



**CB120W CB240W CB280W CB480W: Smart Battery Chargers**

Thank you for having chosen one of our products for your work.  
 We are certain that it will give the utmost satisfaction and be a notable help on the job.

**General Description**

CB series is Charge & Testing devices in “Switching technology” and “Battery Care philosophy”, since many years parts of the know-how ADEL system. This technology led to the development of this advanced multi-stage battery charging, completely automatic and suited to meet the most advanced requirements of battery manufacturers. The Battery Care concept is based on algorithms that implement rapid and automatic cycle of battery charging, battery charge optimization during time, flat batteries recovery and real time diagnostic during installation and operation. The Real Time Auto-diagnostic system, monitoring battery faults such as, elements in short circuit, accidental reverse polarity connection, disconnection of the battery, they can easily be detected and removed by help of Blink Code of Diagnosis Led; during the installation and after sell. Each device is suited for all battery types, jumper selection sets a predefined curves for: Open Lead Acid, Sealed Lead Acid, Gel, Ni-Cd and Li-Ion. A rugged casing with bracket for DIN rail mounting provides IP20 protection degree.



**Main Characteristics**

- Input: Single-phase 115 – 230– 277 Vac
- Output Battery: charging: 24 Vdc 10A – 20 A  
12 Vdc 10A – 35 A
- Suited for the following battery types: Open Lead Acid, Sealed Lead Acid, Lead Gel, Ni-Cd and Li-Ion
- Automatic diagnosis of battery status and battery Life Test function (Battery Care)
- Switching technology- High efficiency
- Three charging levels: luou Bulk, Absorption, Float
- Protected against short circuit, Over Load and inverted polarity
- Output dry contact for discharged or damaged battery
- Output dry contact for Mains or Back-Up
- Protection degree IP20 - DIN rail; Space saving
- Temperature Compensated Charging
- ADELBUS connection: ModBus (RTU)

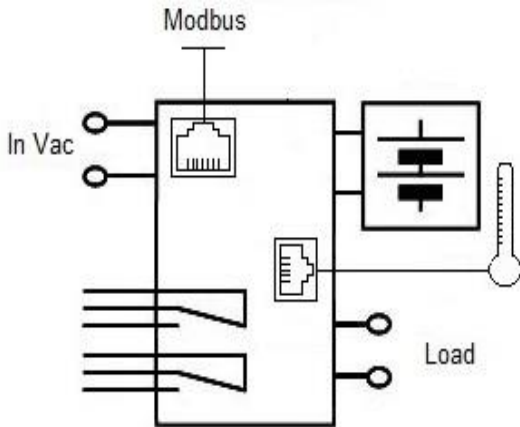

**Safety and warning notes**

**WARNING** – Explosion Hazard Do not disconnect Equipment unless power has been switched off or the area is known to be non-hazardous.



**WARNING** – Explosion Hazard. Substitution of components may impair suitability for class I, Division 2.

**WARNING** – Switch off the system before connecting the module. Never work on the machine when it is live. The device must be installed in according with UL508 or UL 60950. The device must have a suitable isolating facility outside the power supply unit, via which can be switched to idle. Danger of fatal Injury!

**Connection (terminal and wiring):**

**Cable Connection:** The following cable cross-sections may be used:

	Solid (mm <sup>2</sup> )	Stranded (mm <sup>2</sup> )	AWG	Torque (Nm)	Stripping Length	All In One (Size)	1 Phase L N PE Input AC	1 Phase L N PE Input AC
In:	0.2 – 2.5	0.2 – 2.5	24 – 14	0.5 – 0.6 Nm	7 mm	Size 1 and 2		
	4.0	6.0	30 – 10	0.8 – 1.0 Nm	7 mm	Size 3 and 4		
Out:	0.2 – 2.5	0.2 – 2.5	24 – 14	0.5 – 0.6 Nm	7 mm	Size 1 and 2		
	4.0	6.0	30 – 10	0.8 – 1.0 Nm	7 mm	Size 3 and 4		
Signal:	0.2 – 2.5	0.2 – 2.5	24 – 14	0.5 – 0.6 Nm	7 mm	All types		

The connection is made by the screw type 2.5 mm<sup>2</sup> or 4.0 mm<sup>2</sup> terminal blocks. Use only copper cables that are designed for operating temperatures of > 75 °C. Wiring terminal shall be marked to indicate the proper connection for the power supply. Output Power connections:

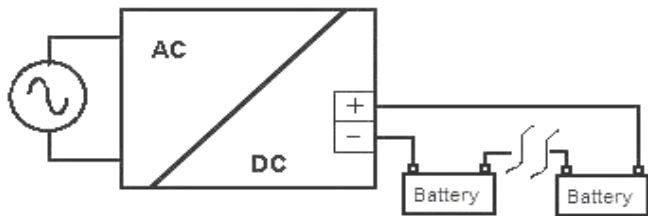

### Normal connection: Battery & Testing Charger:

Typical application for CBxxyy device:  
 N°1 battery (12 Vdc) for CB12yy;  
 N°2 battery (12 Vdc) connected in Series for CB24yy;

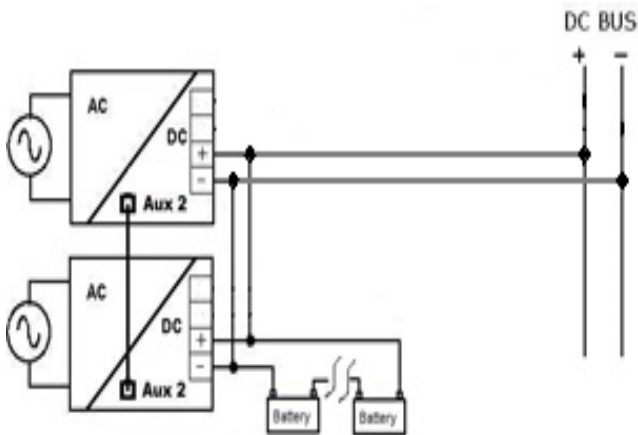

### “Redundancy” Connection

It's possible to request the Redundancy option for the model CB2420AR. Just connect the two CB via the RJ45 cable to AUX2 and power on them (also at different times), automatically one of the CB becomes the real battery charger (indicated by a flashing LED diagnosis according to the usual frequency) while the second holds steady on the LED diagnosis. On both pieces is active the management of alarms. If the piece that charge turns off (or break!) the second automatically begins charging. If there is no communication between the two CB has alarm with flash = code 11 blinks, under these conditions both the CB trying to charge the battery (situation not recommended) to which it is appropriate to human intervention, just reconnect the two pieces and the situation normalizes.

### Auxiliary Load Connection (Size 4)

Typical application for Auxiliary device, one output for Load “DC Bus”, one Input/Output for connection to the battery.  
 N°1 battery (12 Vdc);  
 N°2 battery (24 Vdc) connected in Series;

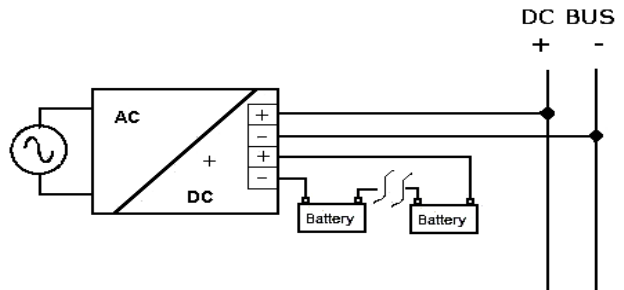

### Operating and Display Element:

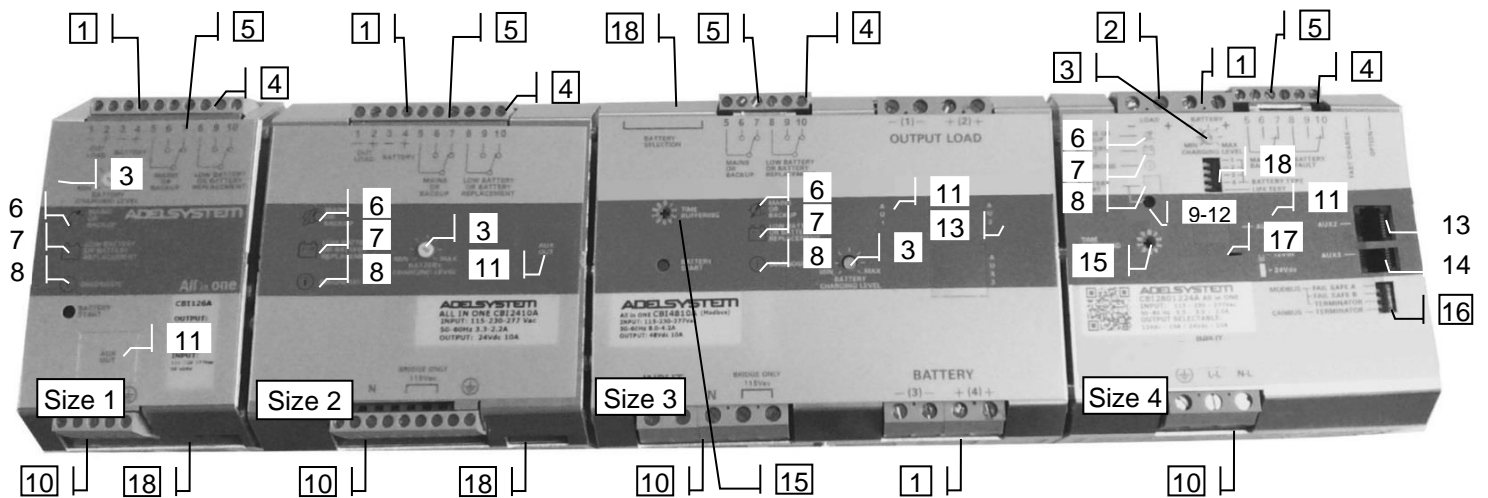

### No. 1: Battery Connection Port:

Connect the battery between pin. 3 (-) and 4 (+)  
 One battery (12 Vdc) for CB12yy;  
 Two battery (12 Vdc) connected in Series for CB24yy

### No. 2: Output Load: (Size 4)

If Present on the device  
 Connect this Output to the load 1 (-). 2 (+).  
 (Output Load It is to supply Auxiliary Load)

### No. 3: Charging Level Current:

In order to protect the battery from excessive charging currents, the device allows you to limit the maximum charge current by adjusting the trimmer. It allows you to limit from max  $I_n$  up to 20% of current  $I_n$ . To determine the maximum battery charge current, see the battery manufacturer's Data Sheet, If it is not possible, consider that on average the maximum charge current is 10% of Ah's rated battery current; The data is suitable for both Lead Acid and NiCd batteries.

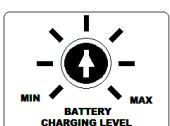

## No. 4, 5 Signal Ports (Output Isolated):

Connections for,

No. 5: MAINS OR BACKUP: Input Mains On/Off. Contact: 5,6,7

No. 4: LOW BATTERY, BATTERY REPLACEMENT, FAULT BATTERY or FAULT SYSTEM Contact: 8,9,10

### Relay Contact Rating:

Max.DC1: 30 Vdc 1 A; AC1: 60 Vac 1A : Resistive load (EN 60947-4-1)

Min.1mA at 5 Vdc: Min. permissive load

Signal Output port true table:		Port N°5 - Led N°6 Mains/Back-Up		Port N°4 - Led N°7 Fault Battery	
		5-6 Closed	5-7 Closed	8-9 Closed (OK)	8-10 Closed
Mains Input Vac	ON	■ - led Off		■ - led Off	
	OFF		■ - led On (1)	■ - led Off	
The battery in BackUP it is less than 30% cap?	YES		■ - led On		■ - led On
	NO		■ - led On	■ - led Off	
Battery or system Fault?	YES	■ - led Off			■ - led On (2)
	NO	■ - led Off		■ - led Off	

### Note:

(1) For better efficiency of the system, filter relay Mains/Back up with a delay of at least 5 seconds before give alarm Main Lost, example: connection to PLC.

(2) See Diagnosis Led

## No. 6, 7 and 8 Display Signals

No.6: Led Mains/Back Up: Input Mains On/Off

No.7: Led Low Battery(capacity less than 30%), Fault connections systems, Battery replacement.













No.8: Led DIAGNOSIS: Battery charge mode,

Led Diagnosis. Diagnosis of the system through "blinking code" signal Light

### State of Charge

Monitoring Control Chart:	State	Led DIAGNOSIS (No.8)	LED BATTERY FAULT (No.7)
Charging Type	Float	1 Blink/2 sec	OFF
	Absorption	1 Blink/sec	OFF
	Boost	2 Blink/sec	OFF
	Recovery	5 Blink/sec	OFF

### Fault Battery / Fault System

System Auto Diagnosis	Reverse polarity or high battery Voltage (over 32.5Vdc for CB 24xxA)	1 Blink/pause 	ON
	Battery No connected	2 Blink/pause 	ON
	Element in Short Circuit	3 Blink/pause 	ON
	Over Load or short circuit on the load	4 Blink/pause 	ON
	Bad battery; Internal impedance Bad or Bad battery wire connection	5 Blink/pause 	ON
	Life test not possible	6 Blink/pause 	ON
	Boost condition; battery discharge after 4 min. of overload.	8 Blink/pause 	ON
	Internal fault	9 Blink/pause 	ON
	Low battery (under 18.5Vdc for CB 24xxA) Only if started from battery, no Mains input, from Jumper N°5 or Push Bottom	10 Blink/pause 	ON
	MODBUS error	11 Blink/pause 	ON
	Life test not possible; Parallel mode on Slave Device	12 Blink/pause 	ON
	Bad battery wire connection; Parallel mode on Slave Device	13 Blink/pause 	ON
	Boost condition; battery discharge after 4 min. of overload; Parallel mode on Slave Device	15 Blink/pause 	ON

## No. 9, 12: Start From Battery Only; No Mains Vac (Size 4)



No. 9: Push-bottom, for 3 sec., in the front panel for switch ON the system without the “Mains input Vac” but only the battery connected.

No.12: It is also available the same function for remote start from the battery, via RTCONN cable connected in the Push-bottom mounted on front Panel of the external system.

N.B.: This Function it is present only if it is enabled Jumper in Option position

## No. 10: Input AC Port pin. L – N:

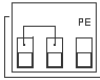

1 Phase Switching Power Supplies L, N, PE ⊕ .

Size 2 and Size 3 BRIDGE ONLY for input 115 Vac, and connect L, N, PE ⊕ .

## No. 11: Auxiliary Output “AUX 1”

Remove the window label to find the connector.

It is possible to connect the Temperature sensor probe and apply it on the battery. The function of the probe is for temperature battery compensation. With this it is possible to active the specifications of the EN54-4 fire norm.

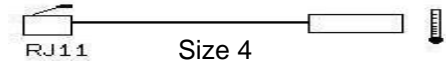
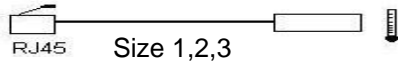

## Battery Temperature Compensation Charge (not for NiCd)

Connecting to Auxiliary Output AUX1 the cable RJTEMP (supplied separately), the CB will vary the voltage of battery charging depending on the temperature:

Fast Charge	Float charge
+/-5mV/°C x n. of Cells from -8°C to +45°C	+/-3mV/°C x n. of Cells from -20°C to +45°C
+140mV/Cell ÷ -200mV/Cell compared to the value at 20°C	+120mV/Cell ÷ -120mV/Cell compared to the value at 20°C

The device stop to charge the battery If the temperature is less than -20°C or greater than +45°C. The alarm fault battery could be signalled by 7 blink code.

The sensor placed on cable RJTEMP must be applied on the battery.

## No. 13: Auxiliary Output “AUX 2” (Size 3-4)

Present only in Sizes 3 and Sizes 4, connection MODBUS via RJ45 connector. See instruction MODBUS communications protocol. (CANBUS to be implemented).

## No. 14: Auxiliary Output “AUX 3” (Size 4)

Present only in Sizes 4. The function is the same of Auxiliary Output “AUX 2”

## No. 15: Buffering Time Setting (Size 4)

On model Size 4 is possible to set a buffering time. It can be selected by setting the desired value on the rotary switch 15. Buffering time is initiated when the mains is switched OFF. The LOAD output will be ON for the selected time.

Switch position	0	1	2	3	4	5	6	7	8	9
Buffering Time (min.)	∞	0.5	2	5	10	15	20	30	45	60

If the switch is in position 0, the LOAD output will be in ON state until the battery is completed discharged. Any way to prevent damage risks, the unit disconnects the batteries when a minimum voltage level is reached.

## No. 16: Bus Termination (Size 4)

Read the MODBUS/CANBUS instruction manual to learn about the operational functions available.

Deepswitch Setting always active during all states of the system.

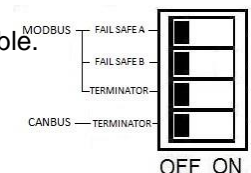

## No. 17: Select Output Voltage (Size 4)

Caution: Switch off the system before Setting the Jumper

Output Voltage Selection	24 Vdc	24 Output Voltage
Output Voltage Selection	12 Vdc	12 Output Voltage

## No. 18: Battery Management Configurations

Preliminary Operations: One device for all battery types.

Completely automatic, all devices are suitable to charge most batteries types thank to User Selectable charging curves. They can charge open lead acid, sealed lead acid, Gel, Ni-Cd and Li-Ion. It is possible to change or add other charging curves connecting the device to a portable PC.

Caution: Switch off the system before Setting the jumper. Only jumper in position 6 is Refreshed also with power ON.



Don't use Ni-Cd charging configuration in battery less than 7 Ah.

Battery Type Selection						
	Jumper Position (Size 1)	Jumper Position (Size 2)	Jumper Position (Size 3)	Dip Switch Position (Size 4)	Float charge (Volt/Cell)	Fast charge (Volt/Cell)
Open Lead					2.23	2.40
(AGM) Low					2.25	2.40
Gel Battery					2.30	2.40
NiCd					1.4/cell (12V:10 cells) (24V:20 cells)	1.5V/cell (12V:10 cells) (24V:20 cells)
Li-Ion (4)					3.45 (12V:4 cells) (24V:8 cells)	3.65 (12V:4 cells) (24V:8 cells)
Custom Charging Curve (5)					Config. by DPY351 or ADELViewsystem.	

Functional Setting					Function
Battery Life test ON					Jumper present or dip switch ON: Life test enabled (not for NiCd)
Fast Charge Enable (3)					Jumper present: Fast Charge enabled. It is possible remote Fast Charge enabling by RTCONN cable
"Start from Battery" (without Input Mains) (1)					Switch ON the system without the "Mains In Vac", only the battery is connected. For connection to external Push button use RTCONN cable
Load Enabling (2)					Present in CB122410A (Size4)

**Notice:**

- Do not leave the jumper in position 5; otherwise, in Backup mode, the battery discharges completely close to zero.
- Contact closed: Auxiliary LOAD enabled  
Contact open: Auxiliary LOAD disabled.  
This function permit to supply all electronic Load in Short Circuit, Over Load Protection.  
In this Way the device it is free to detect all parameters on the battery side.
- Jumper present in Fast Charge means also that every 288h, the device go in "Cycling Refresh Charging". This mode continue for 85 minutes at the same voltage condition: 2.4V/Cell; for Lead Acid Batteries.
- Please note that it is possible to use lithium-charging curve just with a single BMS AND Only by custom request
- By DPY351 or ADELViewsystem it is possible configure a Customized Charging Curve. After programming it is possible disconnect the programmer an use the device as standalone device.

**Battery Care**

The Battery Care philosophy is based on algorithms that implement rapid and automatic charging, battery charge optimization during time, flat batteries recovery and real time diagnostic during installation and operation. The Real Time Auto-diagnostic system, monitoring battery faults such as, elements in short circuit, accidental reverse polarity connection, disconnection of the battery, they can easily be detected and removed by help of Blink Code of



Diagnosis Led; during the installation and after sell. Each device is suited for all battery types, by means of jumpers it is possible setting predefined curves for Open Lead Acid, Sealed Lead Acid, Gel, Ni-Cd and Li-Ion. They guarantees battery reliability in time by continuously testing the internal impedance status, avoids any possible risk of damages and grants also a permanent, reliable and safe connection of the battery to the power supply. The system, through a battery stimulation circuit with algorithms of evaluation of the detected parameter, is able to recognize sulphated batteries or batteries with a short-circuited element.

Battery Test: Automatic. Every 60 sec. check battery connection. Every 220 minute in Float charge, make the test of the battery efficiency. The fault is signalized with relay commutation and diagnosis led blinking.

### **Check for accidental disconnection of the battery cables:**

All In One detects accidental disconnection and immediately switched off the output power.

### **Battery not connected:**

If the battery is not connected no output power.

### **Test of quality wire connections:**

During Float charge the quality (resistance) on the battery connection is checked every 60 sec. This to detect if the cable connection has been properly made.

### **Battery in Open Circuit or Sulphated:**

Every 220 minute. The CB tests of internal impedance, in Float charging mode.

### **Reverse Polarity check:**

If the battery it is connected with inverted polarity, CB is automatically protected.

### **Test of battery voltage connections:**

Appropriate voltage check, to prevent connection of wrong battery types, more or less than the nominal voltage.

### **End of Charge check**

When the battery it is completely full, the device automatically switch in Float charging mode.

### **Check for Battery Cells in short circuit**

Thanks to specific algorithms of evaluation, the CBs recognize batteries with cells in internal short circuit. In Float charge every 220 minute test of element in short circuit.

### **Diagnosis of battery and device**

All CB devices support the user during installation and operation. A Blink code of Diagnosis Led allows to discriminate among various possible faults.

Error conditions, "LED Battery Fault" ON and "LED Diagnosis" blinking with sequence; see Display Signal section.

### **Protection Features**

**On the primary side:** the device is equipped whit an internally fuse. If the internal fuse is activated, it is most probable that there is a fault in the device. If happen, the device must be checked in the factory.

**On the secondary side Battery and load:** The device is electrically protected against short circuits and overload.

**Inversion polarity:** the module it is automatically protected against inversion of battery polarity and connection of load inverted.

**Over current and output short circuit:** the unit limits the output current (see the technical data).

**Deep discharge:** not possible. The unit disconnects the battery when a minimum voltage level is reached.

### **Thermal behaviour**

Surrounding air temperature 50°C. For ambient temperature of over 50°C, the output current must be reduced by 2.5% per °C. Max 70°C At the temperature of 70°C the output current will be 50% of In. The equipment does not switch off in case of ambient temperature above 70°C or thermal overload. The devices are protected for Over temperature conditions "worst case"; in this situations the device Shut-down the output and automatic restart when temperature inside fall.

### **Charging Curve**

Automatic multi-stage operation and real time diagnostic allows fast recharge and recovery of deep discharged batteries, adding value and reliability to the system hosting the CB device. The type of charging is Voltages stabilized and Current stabilized IUoUo. Five charging phases are identified by a flashing code on a Diagnosis LED. To maintain the Output Load in lower Voltage state, don't put jumper in position 6, in this case no boost charge but only Float charge. Fast/Bulk Charge means also that every 288h, the device go in "Cycling Refresh Charging" for 85 minutes at 2.4V/Cell.

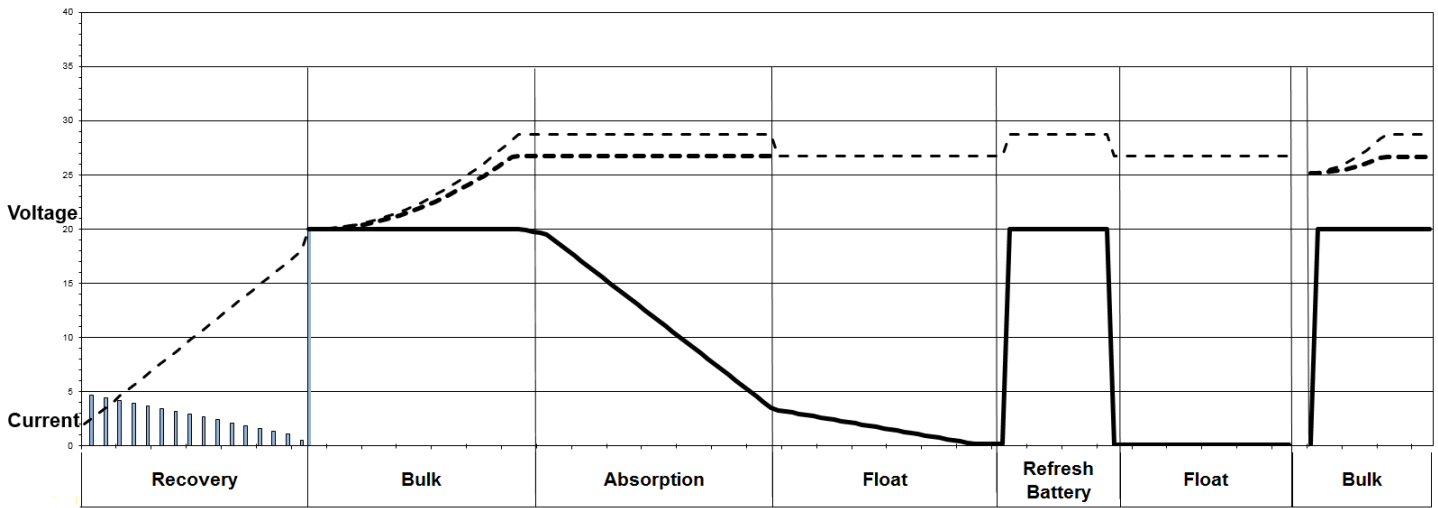

## Standard and Certifications

### Electrical Safety For Mounting:

Device assembling: UL508, IEC/EN 60950 (VDE 0805) and EN 50178 (VDE 0160). Installation according: IEC/EN 60950. Input / Output separation: SELV EN 60950-1 and PELV EN 60204-1. Double or reinforced insulation. Safety of Electrical Equipment Machines: EN 60204-1.

**CE** In According to EMC 2014/30/UE and Low voltage directive 2014/35/UE

**Safety Standards:** EN IEC 62368-1: 2014/AC:2015

### EMC Standards Immunity:

EN 61000-4-2, EN 61000-4-3, EN 61000-6-2, EN 61000-4-4, EN 61000-4-5.

### EMC Standards Emission:

EN 61000-6-4, EN 61000-6-3, EN 61000-3-2 (see data sheet for each device)

### Conformity to:

EN60950 / UL60950-1 and CSA C22.2 No. 60950-1-07 (Information Technology Equipment) – Safety – Part1: General Requirement. 

IEC/EN 60335-2-29 Battery chargers

Electrical safety EN54-4 Fire Detection and fire alarm systems;

DIN41772: Charging curve; DIN41773: Characteristic Curve for charging Lead Acid and Nickel-Cadmium batteries.

### Approved:

Devices:CB1210A,

EN60950 / UL60950-1 and CSA C22.2 No. 60950-1-07 (Information Technology Equipment) – Safety – Part1: General Requirement. 

## Rail Mounting:



All modules must have a minimum vertical and horizontal distance of 10 cm to this power supply in order to guarantee sufficient auto convection. Depending on the ambient temperature and load of the device, the temperature of the housing can become very high.

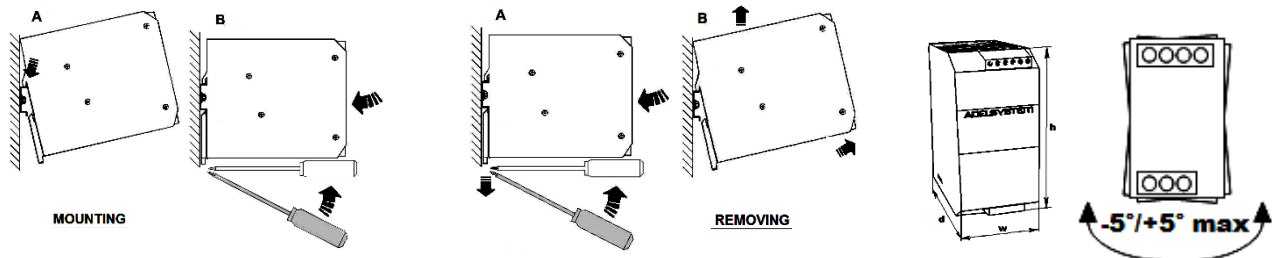

CB Charge & Testing					
					
Input (Volt)	115 – 230 – 277Vac	115 – 230 – 277Vac	115 – 230 – 277Vac	115 – 230 – 277Vac	115 – 230 – 277Vac
Output (Vdc – A – W)	12Vdc – 10A – 120W	12Vdc – 35A – 480W	24Vdc – 10A – 240W	24Vdc – 20A – 480W	12-24V/15-10A/280W
Model	CB1210A	CB1235A	CB2410AC	CB2420A	CB122410A
<b>INPUT DATA</b>					
Nominal Input Voltage	115 – 230 – 277Vac	115 – 230 – 277Vac	115 – 230 – 277Vac	115 – 230 – 277Vac	115 – 230 – 277Vac
Input Voltage Range	90 – 305Vac	90 – 135Vac 180 – 305Vac	90 – 135Vac 180 – 305Vac	90 – 135Vac 180 – 305Vac	90 – 305Vac
Inrush Current (Vn and In Load) I't	≤ 16 A ≤ 5msec	≤ 35 A ≤ 5msec	≤ 16 A ≤ 5msec	≤ 35 A ≤ 5msec	≤ 16 A ≤ 5msec
Frequency	47 – 63 Hz ±6%	47 – 63 Hz ±6%	47 – 63 Hz ±6%	47 – 63 Hz ±6%	47 – 63 Hz ±6%
Input Current (115 – 230Vac)	2.4 – 1.2A	8.0 – 4.2A	3.3 – 2.2A	8.0 – 4.2A	3.3 – 2.2A
Internal Fuse	4A	10A	6.3A	10A	6.3A
External Fuse (recommended)	10A	16A	16A	16A	16A
<b>OUTPUT DATA</b>					
Output Vdc / I <sub>o</sub>	12Vdc – 10A	12Vdc – 35A	24Vdc – 10A	24Vdc – 20A	12Vdc 15A/24Vdc 10A
Minimum load	No	No	No	No	No
Efficiency (50% of In)	≥ 89%	≥ 91%	≥ 88%	≥ 91%	≥ 91%
Short-circuit protection	Yes	Yes	Yes	Yes	Yes
Over Load protection	Yes	Yes	Yes	Yes	Yes
Over Voltage Output protection	Yes	Yes	Yes	Yes	Yes
Reverse battery protection	Yes	Yes	Yes	Yes	Yes
Detection of element in short circuit	Yes	Yes	Yes	Yes	Yes
<b>BATTERY CHARGER OUTPUT</b>					
Boost – Bulk charge (Typ. at I <sub>o</sub> )(1)	14.4Vdc	14.4Vdc	28.8Vdc	28.8Vdc	28.8Vdc
Max.Time Boost–Bulk charge (Typ. at I <sub>o</sub> )	15h	15h	15h	15h	15h
Min.Time Boost–Bulk charge (Typ. at I <sub>o</sub> )	1min.	1min.	1min.	1min.	1min.
Float charge (Typ. at I <sub>o</sub> ) (1)	13.75Vdc	13.75Vdc	27.5Vdc	27.5Vdc	27.5Vdc
Recovery Charge	2 – 9Vdc	2 – 9Vdc	2 – 18Vdc	2 – 18Vdc	2 – 10Vdc /2 – 20Vdc
Switching on after applying mains voltage	2.5sec.	1sec.	2.5sec.	1sec.	3sec.
End of charging current Bulk - Absorption to Float	0.3A	0.3A	0.3A	0.3A	6% of charging current limiting
Charging max I <sub>o,att</sub>	10A ± 5%	35A ± 5%	10A ± 5%	20A ± 5%	15A ± 5% /20A ± 5%
Charging current Limiting I <sub>o</sub> (I <sub>o,reg</sub> )	Yes	Yes	Yes	Yes	Yes
Quiescent Current	≤100mA	≤100mA	≤100mA	≤100mA	≤100mA
<b>SIGNAL OUTPUT (RELAY)</b>					
Main or Backup Power	Yes	Yes	Yes	Yes	Yes
Low Battery and Fault Battery	Yes	Yes	Yes	Yes	Yes
<b>AUXILIARY OUTPUT (RJ 45 CONNECTION) FOR:</b>					
Temp. Charging probe	Yes	Yes	Yes	Yes	Yes
Remote monitoring display	Yes	Yes	Yes	Yes	Yes
<b>CLIMATIC DATA</b>					
Ambient Temperature operation	-30 ÷ +70°C	-30 ÷ +70°C	-30 ÷ +70°C	-30 ÷ +70°C	-25 ÷ +70°C
De rating T <sup>a</sup> > (In)	> 50° 2.5% °C	> 50° 2.5% °C	> 50° 2.5% °C	> 50° 2.5% °C	> 50° 2.5% °C
Automatic De rating	No	No	No	No	No
Ambient Temperature Storage	-40 – +85°C	-40 – +85°C	-40 – +85°C	-40 – +85°C	-40 – +85°C
Humidity at 25 °C	95% to 25°C	95% to 25°C	95% to 25°C	95% to 25°C	95% to 25°C
<b>GENERAL DATA</b>					
Isolation Voltage (IN / OUT)	3000Vac	3000Vac	3000Vac	3000Vac	3000Vac
Isolation Voltage(IN / PE)	1605Vac	1605Vac	1605Vac	1605Vac	1605Vac
Isolation Voltage(OUT / PE)	500Vac	500Vac	500Vac	500Vac	500Vac
Protection Class (EN/IEC 60529)	IP 20	IP 20	IP 20	IP 20	IP 20
Reliability (MTBF IEC 61709)	> 300 000 h	> 300 000 h	> 300 000 h	> 300 000 h	> 300 000 h
Pollution Degree Environment	2	2	2	2	2
Connection Terminal Blocks Screw Type	2,5mm	4mm	2,5mm	4mm	2,5mm
Protection class (with PE connected)	I	I	I	I	I
Dimension (w-h-d)	65x115x135 mm	150x115x135 mm	100x115x135 mm	150x115x135 mm	100x115x135 mm
Weight	0.65 kg approx	1.5 kg approx	0.85 kg approx	1.5 kg approx	0.85 kg approx
Safety Standard Approval	CE 	CE 	CE 	CE 	CE 
<b>CONNECTION DIAGRAM</b>					
					

(1) - Depend on jumper selection