

Operator manual: ADELSYSTEM reserves the right to change the contents of this document without prior notice.

## 1 “ALL IN ONE” DC UPS SERIES

Thank you for having chosen one of our products for your work.

We are certain that it will give the utmost satisfaction and be a notable help on the job.

## 2 GENERAL DESCRIPTION

Thanks to “All In One” CBI series of DC-UPS, it will be possible to optimize the power management of your system with one single, extremely compact and cost-effective device, connected directly to the mains. The available power is automatically distributed between load and battery giving priority to the load. Battery can supply the load even with mains so the output power to the load can be twice the nominal power if it is required (Power Boost). When mains failure occurs, the load continues to be supplied by the battery in backup mode. It is also possible to switch on the device with no mains directly from battery. The “Battery Care” algorithm performs rapid and automatic charging, battery charge optimization during time, flat batteries recovery and real time diagnosis during installation and operation. Temperature compensation is possible by connecting the temperature sensor probe. The real time auto-diagnostic system monitors battery faults such as sulphated battery, shorted cells, accidental reverse polarity connection or disconnection of the battery. Each fault is signaled by a blink code of Diagnosis Led or via Modbus (only in some models) in order to be easily detected and removed during the installation and after sales. The continuous monitoring of battery efficiency reduces risk of battery damage and allows a safe operation in permanent connection. Predefined curves can be selected by jumpers or DIP switch to optimize the charge of different battery types: Open Lead Acid, AGM and Gel Lead Acid; Ni-Cd are rechargeable using the same device. Charging curves can be customized via Modbus (only in some models). Output dry contacts are used to signal both backup and fault conditions. A rugged casing with bracket for DIN rail mounting provides IP20 protection degree.



When mains failure occurs, the load continues to be supplied by the battery in backup mode. It is also possible to switch on the device with no mains directly from battery. The “Battery Care” algorithm performs rapid and automatic charging, battery charge optimization during time, flat batteries recovery and real time diagnosis during installation and operation. Temperature compensation is possible by connecting the temperature sensor probe. The real time auto-diagnostic system monitors battery faults such as sulphated battery, shorted cells, accidental reverse polarity connection or disconnection of the battery. Each fault is signaled by a blink code of Diagnosis Led or via Modbus (only in some models) in order to be easily detected and removed during the installation and after sales. The continuous monitoring of battery efficiency reduces risk of battery damage and allows a safe operation in permanent connection. Predefined curves can be selected by jumpers or DIP switch to optimize the charge of different battery types: Open Lead Acid, AGM and Gel Lead Acid; Ni-Cd are rechargeable using the same device. Charging curves can be customized via Modbus (only in some models). Output dry contacts are used to signal both backup and fault conditions. A rugged casing with bracket for DIN rail mounting provides IP20 protection degree.

## 3 MAIN CHARACTERISTICS

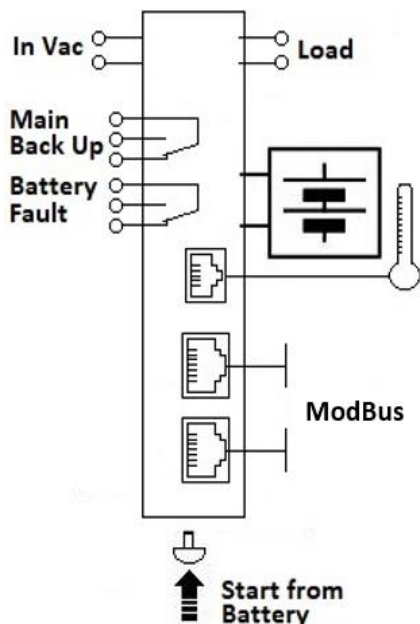

- Universal input voltage: single-phase 115–230-277 Vac
- Load output: 24 Vdc 3,5,10,20A; 12 Vdc 3,6,10,15,35A 48 Vdc 5,10A
- Battery output: 24 Vdc 3,5,10,20A; 12 Vdc 3,6,10,15,35A; 48 Vdc 5,10A
- “All In One” solution: power supply + battery charger + backup module in one single device connected directly to the mains
- Suited for different battery types: Open Lead Acid, Sealed Lead Acid, AGM and Gel Lead Acid; Ni-Cd and Li-ion are available as options. 5-stage IUoU (Recovery, Bulk, Absorption, Float, Refresh Battery) plus Recovery stage for deeply discharged batteries
- Automatic diagnosis of battery status and battery Life Test function (Battery Care)
- Switching technology with high efficiency
- Protected against short circuit, overload and inverted polarity
- Output dry contact for signaling Low Battery or Battery Replacement and Fault system.
- Output dry contact for signaling Mains or Backup
- IP20 protection degree
- Space saving on DIN rail

## 4 SAFETY AND WARNING NOTES



• WARNING – Explosion Hazard. Do not disconnect Equipment unless power has been switched off or the area is known to be non-hazardous.



• WARNING – Explosion Hazard. Substitution of components may impair suitability for class I, Division 2.





• WARNING – Switch off the system before connecting the module. Never work on the machine when it is live. The device must be installed in according with UL62368-1. The device must have a suitable isolating facility outside the power supply unit, via which can be switched to idle. Danger of fatal Injury!



• WARNING - Residual voltage. Wait for 10 seconds before operating on CBI2420A and CBI485A.



- WARNING - Caution high touch current.
- WARNING - Connect to earth before connecting to supply.  

## 5 INSTALLATION NOTES

- This equipment is not suitable for use in locations where children are present.
- This equipment is intended for installation in restricted access area.
- This equipment requires a connection to the PROTECTIVE EARTHING CONDUCTOR.
- An all-pole MAINS switch in accordance with Annex L of UL 62368-1 is required.
- Proper bonding to the end-product main protective earthing termination is required.
- The following end-product enclosures are required: Fire, Electrical, Mechanical.

## 6 CONNECTION

### 6.1 CONNECTION TERMINAL AND WIRING

The following cable cross-sections may be used:

	Solid (mm <sup>2</sup> )	Stranded (mm <sup>2</sup> )	AWG	Torque (Nm)	Stripping Length 	All In One (Size)
In:	0.2 – 2.5	0.2 – 2.5	24 – 14	0.5 – 0.6 Nm	7 mm	Size 1 and 2
	4.0	6.0	30 – 10	0.8 – 1.0 Nm	7 mm	Size 3 and 4
Out:	0.2 – 2.5	0.2 – 2.5	24 – 14	0.5 – 0.6 Nm	7 mm	Size 1 and 2
	4.0	6.0	30 – 10	0.8 – 1.0 Nm	7 mm	Size 3 and 4
Signal:	0.2 – 2.5	0.2 – 2.5	24 – 14	0.5 – 0.6 Nm	7 mm	All types

Connection by the screw, type 2.5 mm<sup>2</sup> or 4.0 mm<sup>2</sup> terminal blocks. Wiring terminal shall be marked to indicate the proper connection for the power supply. Use copper cables only for supply connections. AC main wirings shall be suitable for minimum 80 °C.

Protective Earth connection section must be minimum 4mm<sup>2</sup>/10AWG.

### 6.2 INPUT LINE SYSTEM

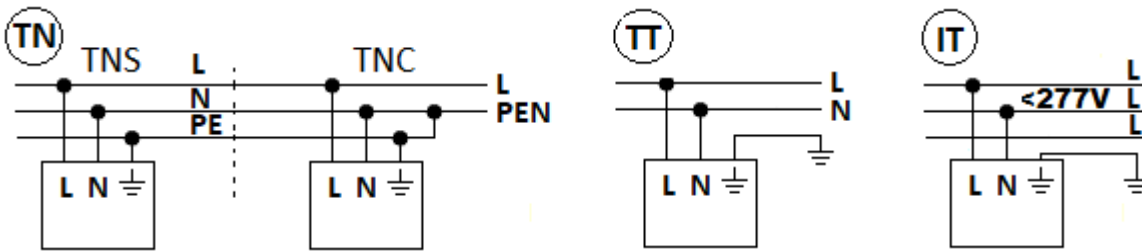

### 6.3 OUTPUT POWER CONNECTIONS: LOAD AND BATTERY

#### 6.3.1 Normal connection

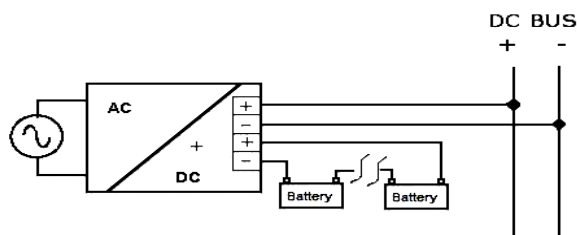

Typical application for All In One device, one output for Load "DC Bus", one Input / Output for connection to the battery.

- N°1 battery (12 Vdc) for CBI 12xx;
- N°2 battery (12 Vdc) connected in Series for CBI 24xx;
- N°4 battery (12 Vdc) connected in Series for CBI 48xx;

#### 6.3.2 Parallel connection "Redundancy"

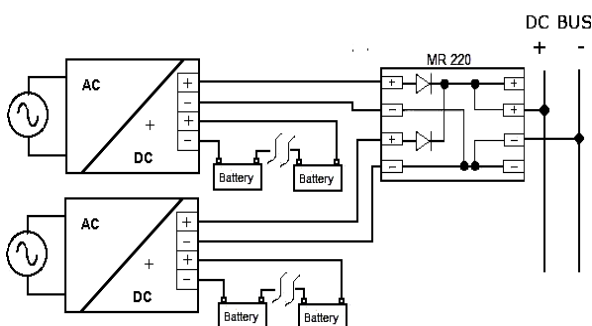

Parallel connection "Redundancy"

Power supplies can be paralleled in case of redundancy concept, to obtain a higher system reliability. Redundant systems may support N+1 redundancy to safeguard against single-point failures, or to enable hot-swapping of a failed supply without system impact. The simplest way is to put two CBI in parallel. In case one power supply unit fails, the other one is automatically able to support the load current without any interruption. To separate completely a hypothetical device failure, it is necessary add the decoupling diodes which are

included in the Redundancy Module MR220. Recommendations for building redundant power systems: a) Use separate input fuses for each CBI. b) Monitor the individual CBI units by three LED. Each unit has two relays: Mains or backup and Low Battery or Battery Replacement (faulty situation). This feature reports a

faulty unit; see Relay Contact Rating for any technical detail. c) When possible, connect each power supply to different phases or circuits

### 6.3.3 Parallel connection “Double Power”

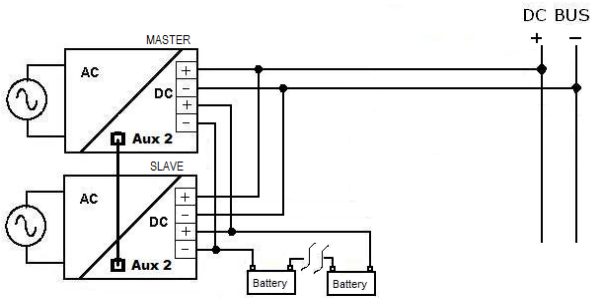

Power supply can be paralleled to increase the output power, devices can be paralleled for 1+1=2 to obtain the double power of a single unit. Only SIZE 3 devices can be connected in parallel to attain the sum of the current at the same output voltage. It is necessary to use a standard UTP or order Cable code: RJCONN45 for RJ45, and connect to Aux2 of each device. The communication protocol is based on CAN2.0A standard.

In this way the system has only One output for the Load

and One connection for the battery. Use separate input fuses for each CBI.

How configure the the device for parallel connection:

1. Connect the first device to the Input main Vac (the battery must be disconnected)
2. Put Time Buffering Switch on position 9. Press 3 time Config button N°9. After press 3 time, Diagnosis LED N°8 start to Blinking 11 time.
3. The device is configured for parallel mode; put the Time Buffering Switch on position 0
4. Repeat the point: 1,2,3, in the second device
5. Connect the Aux2 for each device with RJCONN45. Connect the Aux2 for each device with RJCONN45. Within 5-7 sec the devices goes in Automatic configuration: Master-Slave. The devices decide themselves their Master and Slave assignment randomly. The assignment is done at every power on, or after the connection of the RJ45 cable. Master device provide all the visual signals, the Slave device maintain the diagnosis LED always ON.
6. Make sure that the two CBI have the same settings: Battery type, Charging level current, Time buffering, Life test...
7. Use the alarm contacts of both the two devices and drive them as needed.
8. For Start Battery there are two way, without mains voltage:
  - push start button on both units
  - connect Cable "RTCONN" on position 5, to connect pushbutton on a front panel.

### 6.3.4 Series connection:

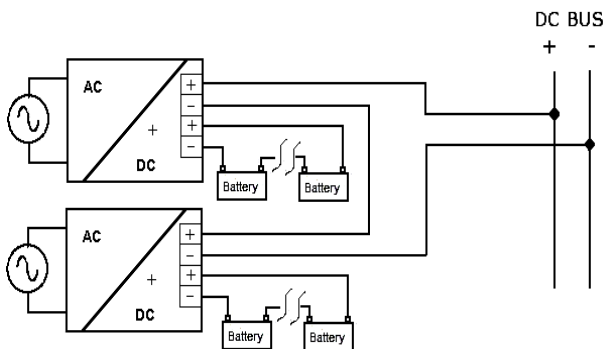

It is possible to connect as many units in series as needed, provided the sum of the output voltage does not exceed 150Vdc. a) Voltages with a potential above 60Vdc are not SELV anymore and can be dangerous. Such voltages must be installed with a protection against touching. b) For serial operation use power supplies of the same type. c) Earthing of the output is required when the sum of the output voltage is above 60Vdc. d) Keep an installation clearance of 10 mm (left/right) between two power supplies and avoid installing the power supplies on top of each other. Note: Avoid return voltage (e.g.

from a decelerating motor or battery) which is applied to the output terminals.

## 6.4 OUTPUT LOAD (MAINS INPUT ON)

The output Load in normal mode, Mains Input Vac Voltage present, follows the charging battery dc output voltage. The minimum and maximum range stabilized are the following:

CBI 12xx:11 – 14,4 Vdc; 15,5 Vdc for NiCd (Without battery connected out. Voltage fixed at 12Vdc)

CBI 24xx:22 – 28.8 Vdc; 30 Vdc for NiCd (Without battery connected out. Voltage fixed at 24Vdc)

CBI 48xx:44 – 57.6 Vdc; 62 Vdc for NiCd (Without battery connected out. Voltage fixed at 48Vdc)

Thanks to the All In One units, it will be possible to manage the power. The available power, is automatically allocated between load and battery: supplying power to the load is the first priority of the unit; thus it is not necessary to double the power and also the power available for the battery will go to the load if the load requires it.

In “Power Boost Mode” the maximum current on the load output is the 2 times the rated current  $2 \times I_n$  ( $I_{load} = I_n + I_{batt}$ ) in continuous operation and 3 times the rated current  $3 \times I_n$  ( $I_{load} = 2I_n + I_{batt}$ ) for 4 seconds; after this power the devices is electrically protected against overload and short circuit.

- In “Power Boost Mode”, if the the battery provide current to the load for longer than 4 minutes, the device outputs a message (8 Blink) to warn that the battery is discharging.
- If the Mains Input Voltage fall below a Threshold level (50% of the Typ. Vac input) the battery is immediately connected to the Output Load, without any interruption.
- Voltage dips: In this situation the voltage in the output load is the same of the battery.

- **To Avoid deep battery discharge**, the battery will supply the load until battery voltage reaches the minimum V/cell. Below this level the device automatically switches off to prevent Deep discharge and battery damage.

## 6.5 OUTPUT LOAD: TIME BUFFERING MODE (MAINS INPUT OFF)

Some example of buffering time depending on LOAD Output in function to the Ah of the battery.

Buffering Time	BATT1.2 Ah	BATT 3 Ah	BATT7.2 Ah	BATT12 Ah	BATT100 Ah
Load 1.5 A	20 min	60 min	200 min	400 min	/
Load 3 A	8 min	30 min	120 min	240 min	/
Load 5 A	3 min	15 min	55 min	100 min	/
Load 7.5 A	2 min	10 min	30 min	60 min	/
Load 10 A	No	7 min	20 min	45 min	20 h
Load 12 A	No	3 min	12 min	30 min	600 min
Load 15 A	No	No	9 min	20 min	400 min
Load 20 A	No	No	7 min	13 min	240 min

## 7 LAY-OUT AND CONNECTIONS

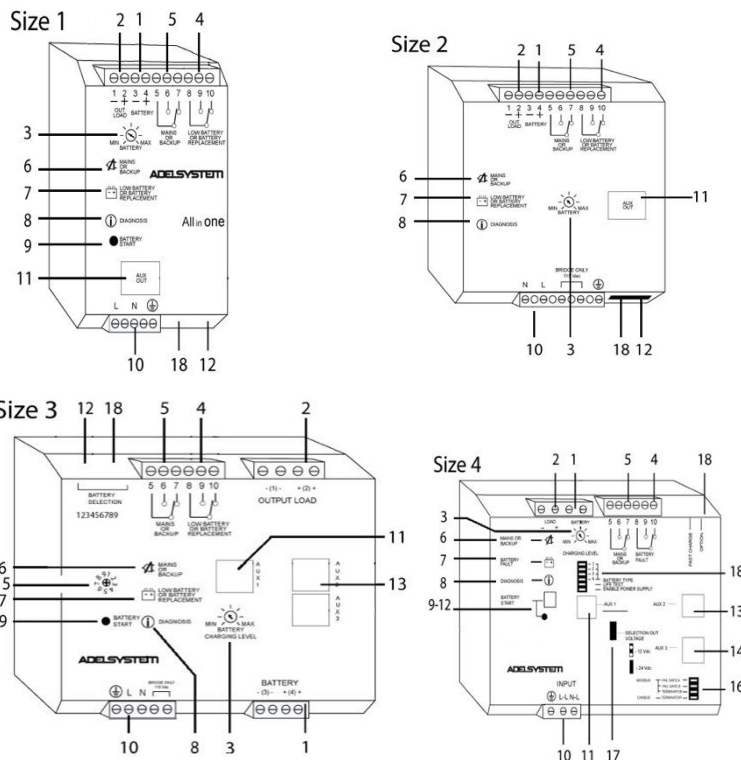

1	Battery
2	Load
3	Charging Current Limiter
4	Fault System
5	Mains-BackUp
6	Mains-BackUp LED
7	Fault LED
8	Diagnosis LED
9	Config/Start From Battery
10	Input Vac
11	Aux 1 (RJTemp)
12	Start From Battery (Connector)
13	Aux 2
14	Aux 3
15	Buffering Time
16	Bus Termination
17	12/24 Output
18	Battery Config.

## 8 INPUT AND OUTPUT LOAD AND BATTERY CONNECTION

### 8.1.1 Input AC Port L – N:

No.10



Single phase Switching Power Supplies L, N, PE ⊕.



Size 2 and Size 3 BRIDGE ONLY for input 115 Vac, and connect L, N, PE ⊕.

### 8.1.2 Battery Connection Port:

No.1: Connect the battery between: terminal 3 (–) and 4 (+)

One battery (12 Vdc) for CBI12xx;

Two battery (12 Vdc) connected in Series for CBI24xx;

Four battery (12 Vdc) connected in Series for CBI48xx;

### 8.1.3 Output Load:

No.2: Connect this Output to the load, terminal 1 (–) and 2 (+).

## 8.2 SELECT OUTPUT VOLTAGE (ONLY SIZE4 CBI280)

No.17: Caution: Switch off the system before setting the Jumper. The Jumper is detected at the device power-up only.

Output Voltage Selection	 - 24 Vdc	Jumper 24V Output Voltage
Output Voltage Selection	 - 12 Vdc	No Jumper 12V Output Voltage

## 9 DRIVE AND MONITORING

### 9.1 FAULT - STATUS CONDITIONS

### 9.2 ISOLATED RELAY (SIZE:1,2,3,4):

#### 9.2.1 STATUS: Mains or Backup: Input Mains On/Off.

- No.5 Relay Contacts: 5, 6, 7
- No.6: Led

#### 9.2.2 FAULT: Low Battery, Battery Replacement, Faulty Battery or Faulty System

- No.4 Relay Contacts: 8,9,10
- No.8: Led DIAGNOSIS: Diagnosis of the system through “blinking code” light signal

#### 9.2.3 Back Up and Fault: Relay and LED Conditions

		Mains/Back-Up		Fault Battery o System	
		Port N°5 Relay	Led N°6	Port N°4 Relay	Led N°7
Mains Input Vac	ON	5-6 Closed	■ - led off	8-9 Closed	■ - led off
	OFF	5-7 Closed	■ - led On (1)	8-9 Closed	■ - led off
Battery SOC less than 30%	YES	5-7 Closed	■ - led On	8-10 Closed	■ - led On (2)
	NO	5-7 Closed	■ - led On	8-9 Closed	■ - led off
Battery or system Fault?	YES	5-6 Closed	■ - led off	8-10 Closed	■ - led On
	NO	5-6 Closed	■ - led off	8-9 Closed	■ - led off

Note:

(1) Contact relay Mains/Back switch at least 5 seconds after disconnection of Power.

(2) See Diagnosis Led

#### 9.2.4 Relay Contact Rating:

Max.DC1: 30 Vdc 1 A; AC1: 60 Vac 1A: Resistive load (EN 60947-4-1).Min.1mA at 5 Vdc: Min. permissive load

### 9.3 NOT ISOLATED OUTPUT (SIZE 5):

#### 9.3.1 STATUS: Mains or Backup “Input Mains On/Off“.

- No.5 Output ON: open drain referred to Load negative terminal; requires an external DC power source (max 48Vdc) – drain current: 20 mA Nom ; 40 mA Max for 3 sec
- No.6: Led ON

#### 9.3.2 FAULT 1: Low Battery, Battery Replacement, Faulty Battery or Faulty System

- No.4 Output ON: open drain referred to Load negative terminal; requires an external DC power source (max 48Vdc) –drain current: 20 mA Nom ; 40 mA Max for 3 sec
- No.8: Led DIAGNOSIS: Diagnosis of the system through “blinking code” light signal

#### 9.3.3 FAULT 2: Rectifier Alarm

- No.4 Output ON: open drain referred to Load negative terminal; requires an external DC power source (max 48Vdc) – drain current: 20 mA Nom ; 40 mA Max for 3 sec
- No.8: Led DIAGNOSIS: Diagnosis of the system through “blinking code” light signal













### 9.4 CHARGING MODE STATUS

	Status	Diagnosis (No.8)	Fault Battery (No.7)
Charging Type	Float	1 Blink/2 sec	OFF
	Absorption	1 Blink/sec	OFF
	Bulk	2 Blink/sec	OFF
	Recovery	5 Blink/sec	OFF

### 9.5 FAULTY BATTERY / FAULTY SYSTEM

Auto Diag nois Syst em	Reverse polarity or high battery Voltage (over 32.5Vdc for CBI 24xxA)	1 Blink/pause 	ON
------------------------	---	---	----



Battery not connected	2 Blink/pause 	ON
Battery element in Short Circuit	3 Blink/pause 	ON
Overload or short circuit on the load	4 Blink/pause 	ON
Bad battery; Internal impedance Bad or Bad battery wire connection	5 Blink/pause 	ON
Life test not possible	6 Blink/pause 	ON
Rectifier Alarm	7 Blink/pause 	ON
Boost condition; battery discharge after 4 min. of overload.	8 Blink/pause 	ON
Internal fault	9 Blink/pause 	ON
Low battery (under 18.5Vdc for CBI 24xxA) Only if started from battery, no Mains input, from Jumper N°5 or Push Bottom	10 Blink/pause 	ON
Master-Slave connection lost between the master and slave on parallel configuration, (AP device only 500W)	11 Blink/pause 	ON
Mains detector failure	12 Blink/pause 	ON
Bad battery wire connection; Parallel mode on Slave Device (AP device only 500W)	13 Blink/pause 	ON
Device over-temperature Alarm	14 Blink/pause	ON
Boost condition; battery discharge after 4 min. of overload; Parallel mode on Slave Device (AP device only 500W)	15 Blink/pause 	ON
Calibration error	16 Blink/pause	ON

## 9.6 START FROM BATTERY ONLY, NO INPUT MAINS VAC



No. 9: Push-button, for 3 sec., in the front panel to switch ON the system without the “Mains input Vac” but only the battery connected. (Not present in CBI 2410XX and CBI 485XX)

No.12 /Jumper n.5) has the same function of remote start from battery, via RTCONN cable connected in the Push-button mounted on front Panel of the external system. Standard function for all products, Size 2 only with code CBI2410A/S and CBI485A/S. Do not leave jumper in this position, otherwise the system will discharge completely the battery. Only push button.

## 9.7 BUFFERING TIME SETTING

No.15: On Size 3 model it is possible to set a buffering time. The desired value can be selected on the rotary switch 15. Buffering time is initiated when the mains is switched OFF. The LOAD output will be ON for the selected time.

Switch position	0	1	2	3	4	5	6	7	8	9
Buffering Time (min.)	∞	0.5	2	5	10	15	20	30	45	60

If the switch is in position 0, the LOAD output will be in ON state until the battery is completely discharged. In any case, to prevent damage the unit disconnects the batteries when a minimum voltage level is reached. The LOAD output will be in ON state until the battery is completely discharged.

For Size 1 and 2 units it is possible to request factory customized versions with specific buffering time setting, choosing the extension CBIxxxxASDx. For Size 4 it is possible to set a buffering time only by Modbus RTU RS485 or via ADELViewSystem software, Holding Register 40104, same feature also for Size 3.

Be Careful: When the Time Buffering function it is Enabled, please refer to Cap. 10.3 section “Functional Setting” and Note 2, to set Jumper UPS Disabling.

## 10 BATTERY CARE

The Battery Care philosophy is based on algorithms that implement rapid and automatic charging, battery charge optimization during time, flat batteries recovery and real time diagnostic during installation and operation. Elements in short circuit, accidental reverse polarity connection, disconnection of the battery, can easily be detected and removed by help of Blink Code of Diagnosis Led, during the installation and after sale. Each device is suited for all battery types, it is possible setting predefined curves for Open Lead Acid, Sealed Lead Acid, Gel, Ni-Cd, Li-Ion. They guarantee battery reliability in time by continuously testing the internal impedance status, avoiding any possible risk of damage and granting a permanent, reliable and safe connection of the battery to the power supply. The system is able, through a battery stimulation circuit with algorithms of evaluation of the detected parameter, to recognize sulphated batteries or batteries with a short-circuited element. Battery Test: Automatic. Every 60 sec. battery connection check. Every 220 minutes in Float charge, battery efficiency test. Battery Faults can be monitored by relay and led blinking.

### 10.1 BATTERY CHARGE IN TEMPERATURE COMPENSATED ENVIRONMENT

No. 11 Remove the window label to find the connector: Auxiliary Output “AUX 1”

It is possible to connect the Temperature sensor probe and apply it on the battery. The function of the probe is for temperature battery compensation. With this it is possible to meet the requirements of the EN54- fire certification.

Size 1,2,3

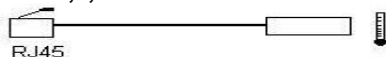

Size 4

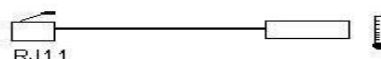

### 10.1.1 Battery Temperature Compensation Charge (not for LI-ion)

Connecting the cable RJTEMP (supplied separately) to Auxiliary Output AUX1, the CBI will adjust the battery charging voltage in relation to the Battery temperature :

<b>Fast Charge: Open Lead, AGM, Gel</b> +/- 5mV/°C x n. of Cells from -8°C to +60°C +140 ÷ -200 mV/Cell compared to the value at 20°C	<b>Float charge: Open Lead, AGM, Gel</b> +/- 3mV/°C x n. of Cells from -20°C to +60°C +120 ÷ -120 mV/Cell compared to the value at 20°C
<b>Fast Charge: Ni-Cd</b> +/- 2.5 mV/°C x n. of Cells from -20°C to +60°C +100 ÷ -100 mV/Cell compared to the value at 20°C	<b>Float charge: Ni-Cd</b> +/- 2.5 mV/°C x n. of Cells from -20°C to +60°C +100 ÷ -100 mV/Cell compared to the value at 20°C

The device stops charging the battery if the temperature is below -20°C or above +60°C. The sensor placed on cable RJTEMP must be applied on the battery.

### 10.2 CHARGING CURRENT LIMITER:

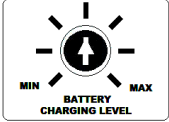

No.3 In order to protect the battery from excessive charging currents, the device allows to limit the maximum charge current by adjusting the trimmer from 20% (Size 1, 2, 5) or 10% (Size 3, 4) to 100% of the rated current. To determine the maximum battery charge current, see the battery manufacturer's Data Sheet or, if not available, consider that typically the maximum charge current is 10% of Ah's rated battery current, for both Lead

Acid Li-ion and NiCd batteries.

### 10.3 BATTERY MANAGEMENT CONFIGURATIONS

Completely automatic, all devices are suitable to charge most batteries types thank to User Selectable charging curves. They can charge open lead acid, sealed lead acid, Gel, Ni-Cd and Li-Ion. It is possible to change or add other charging curves connecting the device to a DPY351 or ADELViewSystem.

#### 10.3.1 Battery Management Configurations (Sizes 1, 2, 3, 4)

No.18 Preliminary Operations: One device for all battery types.

Caution: Switch off the system before Setting the jumper. Only jumper in position 6 is Refreshed also with power ON.

Battery Type chemistry Selection (Only for CBI485A and CBI485A/S). "Size 2"						
	Jumper Position (Size 1)	Jumper Position (Size 2)	Jumper Position (Size 3)	Dip Switch Position (Size 4)	Float charge (Volt/Cell)	Fast charge (Volt/Cell)
Open Lead					2.23	2.40
AGM Low					2.25	2.40
AGM High					2.27	2.40
Gel Battery					2.30	2.40

Battery Type chemistry Selection						
	Jumper Position (Size 1)	Jumper Position (Size 2)	Jumper Position (Size 3)	Dip Switch Position (Size 4)	Float charge (Volt/Cell)	Fast charge (Volt/Cell)
Open Lead / Vented Laed Acid					2.23	2.40
Sealed Lead AGM Lead Crystal					2.25	2.40
Sealed Lead: VRLA – GEL					2.30	2.40
Ni-Cd					1.4V/cell (12V:10 cells) (24V:20 cells) (48V:40 cells)	1.45V/cell (12V:10 cells) (24V:20 cells) (48V:40 cells)
Ni-Mh					1.5V/cell (24V:20 cells)	/
Li-Ion (4) LiFePo4					3.45V/cell 12Vfield: 13.8V 24Vfield: 27.6V 48Vfield: 55.2V	3.65V/cell 12Vfield: 14.6V 24Vfield: 29.2V 48Vfield: 58.4V
Config Mode (5)					Configure with DPY351 or ADELViewSystem	

Functional Setting					
	Jumper Position (Size 1)	Jumper Position (Size 2)	Jumper Position (Size 3)	Dip Switch Position (Size 4)	Function
Battery Life test ON					Jumper present or dip switch ON: Life test enabled (not for NiCd)
Fast Charge Enable (3)					Jumper present: Fast Charge enabled. Remote Fast Charge enabling possible by RTCONN cable
“Start from Battery” (No Input Mains)(1)					System switch ON from battery without mains. For connection to external Push button use RTCONN cable
UPS Disabling (2)					If jumper removed: UPS function disabled. Use RTCONN cable for connection to external Contact.

**Note:**

- 1 Do not leave the jumper in position 5 (Size 1, 3) or position 6 (Size 2) or Battery Start (Size 4); otherwise, in Backup mode the battery is discharged completely close to zero.  
For Size 2 CBI2410A/S or CBI485A/S are required (/S means start with battery functions, otherwise only start with Input Mains)
- 2 UPS Disabling:  
When it is Enabled the Time Buffering function,
  - for the CBI Size 3, Size1 SDXX, CBI size2 SDXX, the function “fast charge” is replaced by “UPS disabling”,
  - for the CBI Size 4 there is an apposit Jumper colled UPS Disabling.
  - Contact closed: back-up UPS enabled. The System shuts down after xx min., depending on the Buffering time selected; Size3 and Size4  
For devices CBI size1 SDXX, CBI size2 SDXX, depends on time minutes required in SD version during The Order. To maintain the contact always closed insert the jumper permanently.
  - Contact open: Inhibit backup function. No UPS enabled.
  - For CBI Size3 : the function is not enabled if Time Buffering is in position Zero. In position Zero, the jumper Fast is enabled otherwise the function is “UPS disable”.
  - In the CBI size1 SDXX and size2 SDXX: the function Fast Charge, it is always enabled.
- 3 Jumper present in Fast Charge means also that every 288h, the device goes in “Cycling Refresh Charging”. This mode continues for 85 minutes at the same voltage condition: e.g. 2.4V/Cell for Lead Acid Batteries.
- 4 The Li-Ion curve is available starting from release: **Size1:**12Vdc Output: S13 R6; 24Vdc Output: S13 R7 **Size2:** 24Vdc Output: S92 R3 **Size3:**12Vdc, 24Vdc, 48Vdc Output: S40 R13 **Size4:** S130 R5
- 5 With this selection it is possible to change the parameters of the selected chemistry.
  - a. First, select the battery chemistry
  - b. Select “Config Mode”.
  - c. Change the parameters with DPY351 or ADELVIEWSystem. After update, it is possible to disconnect the programmer and use the device as standalone device.
  - d. If “Config Mode” is disable, all parameters are reset to their default values for the selected chemistry
  - e. In “Config mode”: it is possible to change the Float voltage and the Bulk voltage. To change the Bulk Voltage you have to modify the Holding register 40073 Bulk and 40077 Absorption.
  - f. In “Config Mode”, the Jumper **Size3** or Switch **Size4** for Fast Charge loses his function. All functions are driven from the Holding Register settings.

**10.4 DIAGNOSTIC AND CONTROLS**

All CBI devices support the user during installation and operation. A Blink code of Diagnosis Led allows to discriminate among various possible faults.

Error conditions, “LED Battery Fault” ON and “LED Diagnosis” blinking with sequence; see Display Signal section.

- Check for accidental disconnection of the battery cables and immediately switch off the output power.
- Battery not connected: If the battery is not connected the device provides alarm within 10 sec.
- Test of quality wire connections: During Float charge the quality (resistance) on the battery connection is checked every 60 sec. This to detect if the cable connection has been properly made.
- Battery in Open Circuit or Sulphated: In Float charging mode, the All In One performs internal impedance test every 220 minutes.



- Reverse Polarity check: If the battery is connected with inverted polarity, the All In One is automatically protected.
- Test of battery voltage connections: Appropriate voltage check, to prevent connection of wrong battery types, above or below nominal voltage.
- End of Charge check : When the battery is fully charged, the device automatically switches in Float charging mode.
- Check for Battery Cells in short circuit: thanks to specific algorithms of evaluation, the Alle In One recognizes batteries with shorted cells. In Float charge every 220 minutes a short-circuit test is carried out.

### 10.5 PROTECTION FEATURES

- **On the primary side:** the device is equipped whit an internally fuse. If the internal fuse is blown, most likely there is a fault in the device. In that case, the device must be returned to factory for repair.
- **On the secondary side Battery and load:** The device is electrically protected against short circuits and overload.
- **Polarity Inversion:** the module is automatically protected against inversion of battery polarity.
- **Over current and output short circuit:** the unit limits the output current (see the technical data).
- **Deep discharge:** not possible. The unit disconnects the battery when a minimum voltage level is reached.

### 10.6 CHARGING CURVE

Automatic multi-stage operation and real time diagnostic allows fast recharge and recovery of deep discharged batteries, adding value and reliability to the system hosting the CBI device. The type of charging is Voltages stabilized and Current stabilized IUoU. Five charging phases are identified by a flashing code on a Diagnosis LED. To maintain the Output Load close to the nominal voltage (12, 24, 48), don't insert jumper in position 6 to disable fast charge. Fast Charge means also that every 288h, the device goes in "Cycling Refresh Charging" for 85 minutes at 2.4V/Cell.

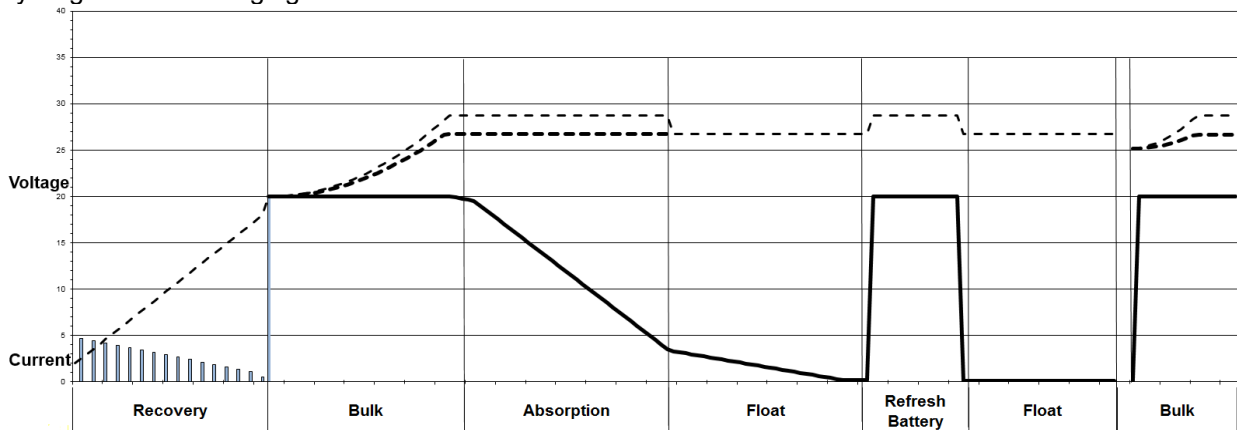

### 10.7 THERMAL BEHAVIOUR

Surrounding air temperature 50°C. For ambient temperature above 50°C, the output current must be reduced by 2.5% per °C. Max 70°C At the temperature of 70°C the output current will be 50% of In. The equipment does not switch off in case of ambient temperature above 70°C or thermal overload. The devices are protected for Over temperature conditions "worst case"; in this situation the device shuts down the output and automatically restarts when the inner temperature falls within limit.

## 11 MODBUS (SIZE 3 - 4)

Some devices are fitted with a Modbus "RTU" communication protocol port; Modbus requires that only one device be the Master, all other devices must be slave.

Hardware interface: RS485.

### 11.1 ELECTRICAL CHARACTERISTICS

The unit is a **SLAVE** in a MODBUS network, with the following specifications:

Transmission mode:	MODBUS RTU
Electrical Interface:	RS485 half-duplex serial line
Baud rate:	4800 / 9600 / 19200 / 38400 (default) bps
Data format:	8 data bits
Parity:	even (default) / odd / none
Stop bits:	1 (parity odd or even) / 1 or 2 selectable (parity none)
Slave address:	configurable in the range 1 (default) to 247
Connector type:	RJ45
Cable:	wire RJ-45 plug

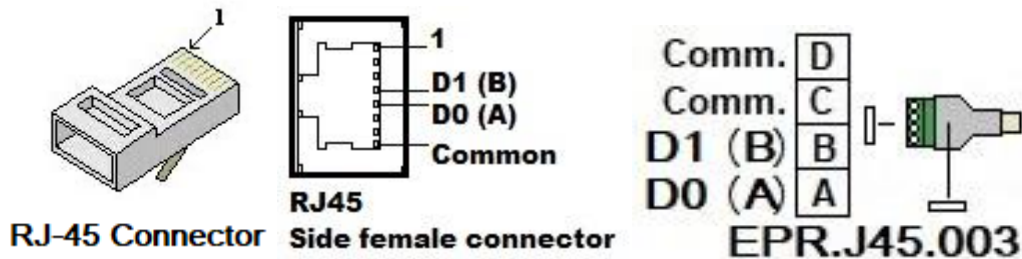

	<b>Size3 - 4</b>
Connector name	AUX2 - AUX3
Pinout (see fig. above)	A = pin 5, B = pin 4, Common = pin 3

## 11.2 HOW TO CONNECT THE DEVICE TO MODBUS

### 11.2.1 Daisy Chain general connection Diagram

To connect the device to Modbus, please use AUX2 and AUX3 Port.

- Port: AUX 2 No. 13 is Present only in Sizes 3 and Sizes 4, MODBUS connection via RJ45 connector.
- Port: AUX 3 No. 14 Present only in Size 4. The function is the same of Auxiliary Output "AUX 2"

### 11.2.2 Connection Diagram Size3 and 4

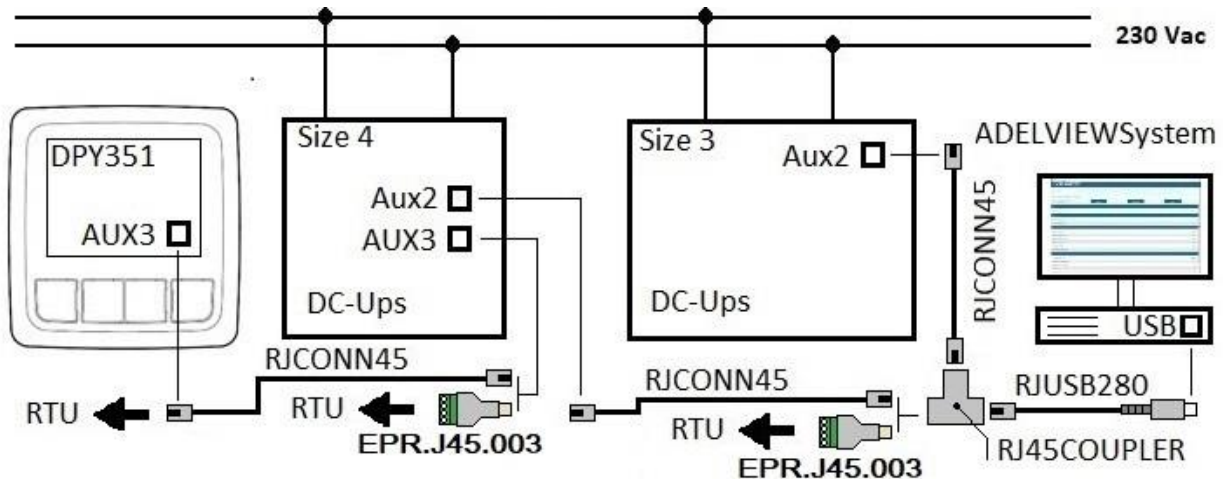

- RJCONN45: normal RJ45 cable also provided by ADELSystem. It is possible to connect in daisy chain up to 32 devices, max distance 1000m, from the Output AUX2 and Aux3.
- In the connection scheme shown above, each slave device must have a unique Modbus device address for proper communication. In order to avoid signal noise, the use of line termination resistors (120 Ohm) is recommended. The effect of signal noise becomes more relevant with long cable length and/or high baud rates. The serial Modbus connection uses an RS485 port for connection between the master port and the corresponding interfaces of the slave according to the EIA/TIA RS485 standard.
- RJUSB280: cable interface RS485 – USB, max length 2m, for connection to PC
- Note: If both, DPY351 and ADELViewSystem, are running in the same network at the same time, The DPY351 must be set in Modbus "Viewmode".
- RJ45COUPLER: is a T connection RJ45 for daisy Chain with CBI Size3 and 4

### 11.2.3 Bus Termination (Size 3)

The fail safe and Line termination resistor for the RS-485 bus, are not provided inside the device and must be installed externally, if necessary, according to the following scheme.

Fail-safe:

- 560 Ohm (Pull Up) to 5 V: Not Present
  - 560 Ohm (Pull Down) to common: Not Present
- Load Terminations:
- 120 Ohm (LT) between lines A – B: Not Present

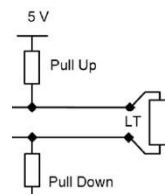

### 11.2.4 Bus Termination (Size 4)

No.16: The Size 4 device includes a full "fail safe" polarization and the bus termination. In the CBI2801224A the fail safe function and line terminators can be individually enabled or disabled by means of the dip-switches located on its front panel, as shown in the following figure:

Fail-safe:

- Fail Safe A, 560 Ohm (Pull Up) to 5 V
- Fail Safe B, 560 Ohm (Pull Down) to 0 V
- Terminations: 120 Ohm (between Modbus lines)
- Terminations: 120 Ohm (between Can lines)

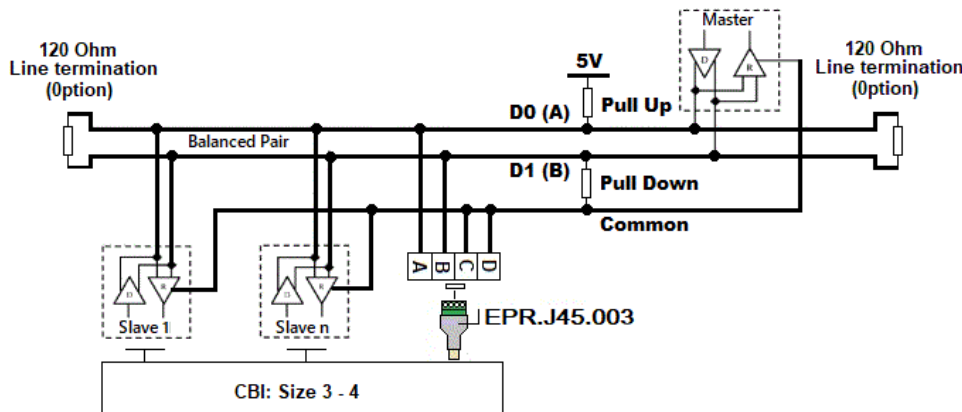
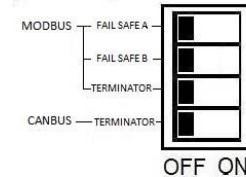

### 11.3 HOW TO CONFIGURE MODBUS

AUX2 and AUX3 ports, are provided for the connection to an external device like: RTU, PC , DPY351.

- For the connection to RTU, PLC or similar devices, refer to the instruction manuals “Modbus specifications” available in the Web Site: [www.adelsystem.com](http://www.adelsystem.com)
- For configuration and monitoring of the parameters inside the devices, download and install “ADELViewSystem” from the Web Site: [www.adelsystem.com](http://www.adelsystem.com).
- Download the Modbus table from Web Site: [www.adelsystem.com](http://www.adelsystem.com), section Additional Data, with details About all data and parameters exchanged between a CBI and a Master Device.
- For the Monitoring and Configurations of one or more ADELSystem devices from enduser friendly , please use the Plug and Play unit DPY351.
- For all details of Modbus configuration refer to the instruction manuals “Modbus specifications” available from the Web Site: [www.adelsystem.com](http://www.adelsystem.com), section Additional Data.

## 12 ADELBUS CONNECTIONS

ADELBus is the ADELSystem network to interconnect devices via Modbus and CANBUS protocols. ADELBus is used as power management system for all connected equipment, such as the DC-Ups, Battery Charger, Power Supply. Every compatible device with ADELBus is equipped with one or two data ports. The devices are simply chained together, forming a local data network. Monitoring panels such as the DPY351 can be used for monitoring and controlling all connected ADELBus equipment.

### 12.1 EVENT BASED COMMANDS

With the ADELBus, a device can be programmed to initiate an action on another connected device. This is done by means of event-based commands.

### 12.2 HOW TO SET UP AN ADELBUS NETWORK

Connections between the devices are made by standard straight ADELBus cables. ADELSystem can supply these cables. These (CAT5) cables are also commonly available at computer supply stores. Twisted pair cable with shield is recommended for CAN connection in noisy environment.

Up to 32 ADELBus devices can be connected together. The power for the network can be provided directly to the connected devices through the ADELBus cable. Otherwise, if that is not sufficient, it is necessary to connect the device by the + and – terminals of connector 1 .

### 12.3 HOW TO SET ADELBUS NETWORK WITH MORE THAN ONE DPY351 (MODBUS VIEW MODE)

In a Modbus network there can only be one master. Normally the DPY351 is the master, it polls the network and it receives information from other ADELSystem devices, which are the slaves. If it is necessary to connect  $N$  DPY351 in the same ADELBus network, then  $N-1$  displays shall be configured in View Mode. In this case only one DPY351 is a master and it polls the devices, the other DPY351s receive the data from the Bus and they take the information into consideration only if these parameters are originated from a device in their list, otherwise they ignore the information.

View Mode is useful also when the master of the network is an external device such as a PC, but there is the need to monitor the status of the network from other places.

To configure the DPY351 in View Mode it is necessary to go in:

*Menu>Menu Config>Other Settings>Modbus View Mode.*

## 13 PC SHUTDOWN

For the Shutdown PC please refer to the special White Paper in the Web Site

## 14 DIN RAIL MOUNTING:



All modules must have a minimum vertical and horizontal distance of 10 cm to this power supply in order to guarantee sufficient auto convection. Depending on the ambient temperature and load of the device, the temperature of the housing can become very high.

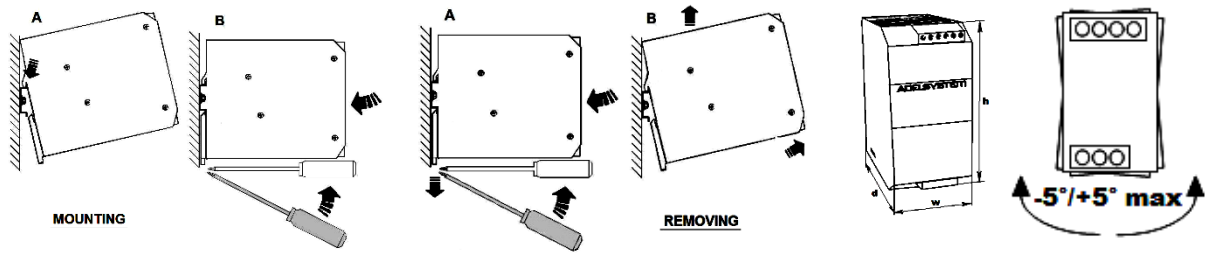

## 15 TECHNICAL DATA

For all technical data, please download the data sheet on the relevant Website for the specific Product.

## 16 BATTERY BANK

### 16.1 BATTERY BANK 12V

BATT 123:	Battery Bank 1 Battery+Enclosure
BATT 123DIN:	Battery Bank 1 Battery+Enclosure DIN
BATT 127:	Battery Bank 1 Battery+Enclosure
BATT 127DIN:	Battery Bank 1 Battery+Enclosure DIN
BATT 1212:	Battery Bank 1 Battery+Enclosure

### 16.2 BATTERY BANK 24V

BAT1.2VRLA:	Battery Bank 2 Batteries+Enclosure DIN
BAT3.4VRLA:	Battery Bank 2 Batteries+Enclosure DIN
BAT7.2VRLA:	Battery Bank 2 Batteries+Enclosure DIN
BAT12VRLA:	Battery Bank 2 Batteries+Enclosure
BTH1.2VRLA:	Battery Bank Enclosure No Battery DIN
BTH3.4VRLA:	Battery Bank Enclosure No Battery DIN
BTH7.2VRLA:	Battery Bank Enclosure No Battery DIN
BTH12VRLA:	Battery Bank Enclosure No Battery

## 17 ACCESSORIES

### 17.1 DIGITAL CABLE

RJCONN45	Cable RJ45/RJ45 (Aux2, Aux3)	RJUSB280	Cable RJ45/USB Size3 – Size4
DPYCONN500	Cable RJ45/RJ45 (Aux2)	RJUSBSD	Connector Cable Shut Down/USB
RJ45COUPLER	RJ45 Three way "Daisy Chain"	ERPJ45003	Connector RJ45/Terminal Block 4 pin
RJ11COUPLER	RJ11 Three way coupler Connect	RJTB280	Connector RJ11/Terminal Block 6 pin

### 17.2 TEMPERATURE SENSORS

RJTEMP451	Temperature Probe Size:1,2,3
RJTEMP453	Temperature Probe Size:1,2,3
RJTEMP111	Temperature Probe Size: 4
RJTEMP113	Temperature Probe Size: 4

### 17.3 CABLE CONNECTORS

RTCONN	Connector Cable Start from battery
--------	------------------------------------

### 17.4 INTERFACES

MR220	DECOUPLER
MRF102	Electronic circuit Breaker

## 18 MONITOR & CONTROL

- DPY351 CONTROL PANEL
- DPY353 DISPLAY PANEL
- DPY354 "ADELVIEW SYSTEM" PC SOFTWARE