

DC Ups CBI60 “AllinOne”

CBI6012A and CBI6024A



Instruction Manual

Thank you for having chosen one of our products for your work. We are certain that it will give the utmost satisfaction and be a notable help on your job and application.

1 Product Description

New revolutionary product, with Ethernet on Board provided with protocol connections: HTTPS, SNMPv3, Modbus TCP. The device also features the ADELBus protocol for connecting other ADELSystem devices. Thanks to “All In One” CBI series of DC-UPS, it will be possible to optimize the power management of your system with one single, extremely compact and cost-effective device, connected directly to the mains. The available power is automatically distributed between load and battery giving priority to the load. Battery can supply the load even with mains so the output power to the load can be twice the nominal power if required (Power Boost). When mains failure occurs, the load continues to be supplied by the battery in backup mode. It is also possible to switch on the device with no mains directly from battery. The “Battery Care” algorithm performs rapid and automatic charging, continuous battery charge optimization, flat batteries recovery and real time diagnosis during installation and operation. Temperature compensation is possible by connecting the temperature sensor probe. The real time auto-diagnostic system monitors battery faults such as sulphated battery, shorted cells, accidental reverse polarity connection or disconnection of the battery. Each fault is signaled by a blink code of Diagnosis Led or via Modbus in order to be easily detected and removed during the installation and after sales. The continuous monitoring of battery efficiency reduces the risk of battery damage and allows a safe operation in a permanent connection. Predefined curves can be selected on the front panel to optimize the charge of different battery types: Open Lead Acid, AGM and Gel Lead Acid; Ni-Cd, Li-Ion are rechargeable using the same device. Charging curves can be customized via Modbus. Output contacts are used to signal both backup and fault conditions. A rugged casing with bracket for DIN rail or Wall mounting.

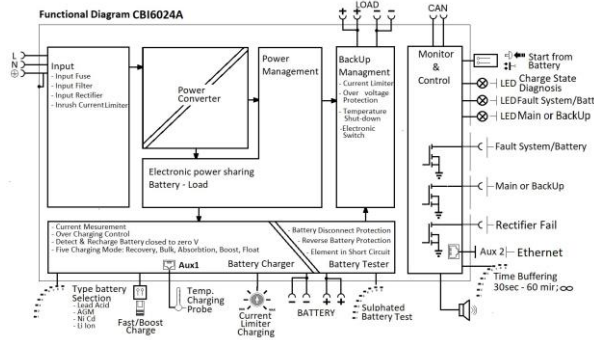

2 Main Characteristics

- Universal input voltage: single-phase 100–277 Vac
- Load output: 24 Vdc 2.5 A; 12 Vdc 5 A
- Battery output: 24 Vdc 2.5 A; 12 Vdc 5 A
- “All In One” solution: power supply + battery charger + backup module in one single device connected directly to the mains
- Suited for different battery types: Open Lead Acid, Sealed Lead Acid, AGM and Gel Lead Acid; Ni-Cd and Li-ion. 5-stage IUoU (Recovery, Bulk, Absorption, Float, Refresh Battery) plus Recovery stage for deeply discharged batteries
- Automatic diagnosis of battery status and battery Life Test function (Battery Care)
- Switching technology with high efficiency
- Protected against short circuit, overload and inverted polarity

- Solid state output contact for signaling Low Battery or Battery Replacement and Fault system.
- IP20 protection degree
- Space saving on DIN rail and wall mount

3 Safety and warning notes



To safely operate this Device please read and follow all instructions carefully before attempting to unpack, install, or operate.

WARNING – Explosion Hazard: do not disconnect equipment unless power has been switched off or the area is known to be non-hazardous.

WARNING – Explosion Hazard. Replacement of components may impair suitability for class I, Division 2.

WARNING – Switch off the system before connecting the module. Never work on the machine when it is live. The device must be installed according to EN50178 or EN60364. The device must have a suitable isolating facility outside the power supply unit, via which it can be switched to idle. Danger of fatal injury!

WARNING – The device is equipped with an internal fuse. If the internal fuse blows up (fails opens), it is most probable that there is a fault in the device. If this failure occurs, the device must be returned to the factory.

4 How to Install

4.1 Mounting

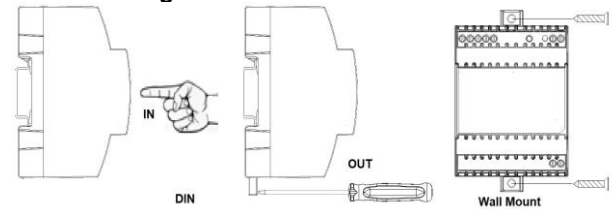

Fig. 1 – Mounting of the CBI60

4.2 Din Rail or Panel Mounting

Fig. 1 shows how to install the CBI60. It is possible to mount the device on DIN rail or on a panel and fix it by 2 screws suggested 2.9x8-16. There is no limit for the panel thickness.

4.3 Device Connection (Fig.2)

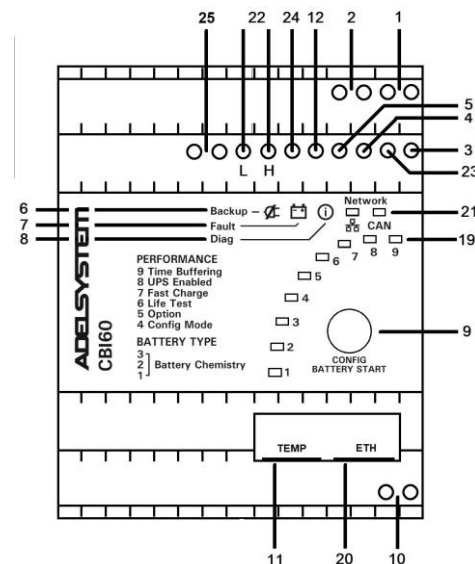

Fig. 2 – Connection terminal

Reference	Description
1	Battery
2	Load
4	System fault – Rectifier alarm
5	Mains – Backup
6	Mains – Backup LED
7	Battery fault – System fault LED

8	Diagnosis LED
9	Configuration – Start from Battery
10	Input Vac
11	Aux1: RJtemp – DPY353
12	Start from Battery: (close to negative load)
19	Battery Config - Life test – Fast Charge – UPS Disabling-Time Buffering
20	Aux4: Ethernet
21	Network Communication LED
22	ADELBus (CAN)
23	Rectifier Alarm
24	SHD: Shield connection for Ethernet "ETH"
25	Battery Sense: Connect to pole + and – of the battery for SoH detection.

4.4 Connection terminal and wiring

The following cable cross-sections may be used:

	Solid (mm2)	Stranded (mm2)	AWG	Torque (Nm)	Stripping Length
In:	0.2–2.5	0.2–2.5	24 – 14	0.5–0.6	7 mm
Out:	0.2–2.5	0.2–2.5	24–14	0.5–0.6	7 mm
Signal:					AMP Modu II

Screw type terminals, 2.5 mm2. Wiring shall be marked to indicate the proper connection for the power supply. Use copper cables only; for power connections use wires suitable for at least 75°C

4.5 Input and Output Battery connection

Primary switch mode power supply for connection to 1-phase AC and DC line systems. For AC line systems (TN, TT and IT system in according to IEC 60364-1) whit rated voltage 110 -240, 50 – 60Hz. Output voltage 12 -24 Vdc , isolated and no-load proof.

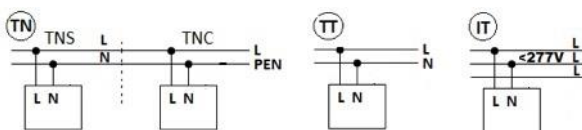

4.5.1 Input AC Port L – N:

Single phase Switching Power Supplies L, N

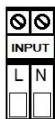

4.5.2 Battery Connection and Load Connection

4.5.1 Battery Connection Port:

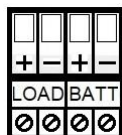

-Connect the battery between: terminal (-) and (+)
 -One battery (12 Vdc) for CBI6012A
 -Two battery (12 Vdc) connected in Series for CBI6024A

4.5.2 Output Load:

Connect this output to the load, terminal (-) and (+).

5 Drive and Monitoring

5.1 Fault - Status conditions

5.1.1 STATUS: Mains or Backup: Input Mains On/Off.

- No.5 Output Open Collector Contact: 1
- No.6: LED

5.2 Fault Battery or Fault System

- No.4 Output Open Collector Contact: 2
- No.7: LED
- No.8: Led DIAGNOSIS: Diagnosis of the system through "blinking code" light signal

5.3 Fault Internal Rectifier

- No.23 Output Open Collector Contact: 3

5.4 Driver Contact open drain:

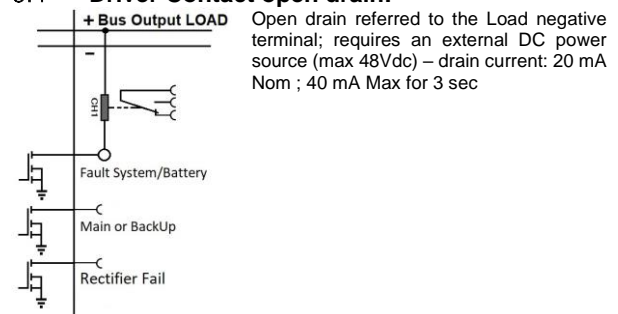

		Mains/Back-Up		Battery or System fault	
		Port N°5	Led N°6	Port N°4	Led N°7
Mains Input Vac	ON	Closed	■ - led off	Closed	■ - led off
	OFF	Open	■ - led On	Closed	■ - led off
Battery SOC less than 30%	YES	Open	■ - led On	Open	■ - led On
	NO	Open	■ - led On	Closed	■ - led off
Battery or system Fault?	YES		■ - led off	Open	■ - led On
	NO		■ - led off	Closed	■ - led off

5.5 Charging Mode Status

Charging Type	Status	Diagnosis (No.8)	Battery fault (No.7)
Charging Type	Float	1 Blink/2 sec	OFF
	Absorption	1 Blink/sec	OFF
	Bulk	2 Blink/sec	OFF
	Recovery	5 Blink/sec	OFF

5.6 Faulty Battery / Faulty System

Auto Diagnosis System	Diagnosis	Battery fault
Reverse polarity or high battery Voltage (over 32.5Vdc for CBI 24xxA)	1 Blink/pause	1 Blink/pause
Battery not connected	2 Blink/pause	2 Blink/pause
Battery element in Short Circuit	3 Blink/pause	3 Blink/pause
Overload or short circuit on the load	4 Blink/pause	4 Blink/pause
Bad battery; internal impedance Bad or Bad battery wire connection	5 Blink/pause	5 Blink/pause
Life test not possible	6 Blink/pause	6 Blink/pause
Rectifier Alarm	7 Blink/pause	7 Blink/pause
Boost condition; battery discharge after 4 min. of overload.	8 Blink/pause	8 Blink/pause
Low battery (under 18.5Vdc for CBI 6024A) Only if started from battery, no mains input	10 Blink/pause	10 Blink/pause
Mains detector failure	12 Blink/pause	12 Blink/pause
Device over-temperature Alarm	14 Blink/pause	14 Blink/pause
Calibration error	16 Blink/pause	16 Blink/pause

5.7 Start from Battery No Input Mains Vac

No. 9: Push-button, max 3 sec., in the front panel to switch ON the system without the "Mains input Vac" but only the battery connected. Same function for additional external Button by connection of pin N°12 (SB). The other side of the external button must be connected to Negative Load.

5.8 Load ON/Off

It is possible to Drive the output Load On/Off by Ethernet connection. This function allows to switch On/Off the load output for many application as, Reset PLC, staircase light timer control, emergency light controls, etc...

5.9 Charging Current limiter:

In order to protect the battery from excessive charging currents, the device allows to limit the maximum charge current by Push Button. Press button (9) for 2 sec., after that in 20 step it is possible to select the limit current.

Press for more than 2 sec. to store the selection in permanent memory.

CBI6024A: from 0 – 3A ; 20 step; 1 step 150mA

CBI6012A: from 0 – 5A ; 20 step; 1 step 250mA

It is possible set the limiting current also by the internal Web Server, please refer to the Ethernet section.

6 Battery Care

The Battery Care philosophy is based on algorithms that implement rapid and automatic charging, battery charge optimization during time, flat batteries recovery and real time diagnostic during installation and operation. Elements in short circuit, accidental reverse polarity connection, disconnection of the battery, can easily be detected and removed by help of Blink Code of Diagnosis Led, during the installation and after sale. Each device is suited for all battery types, it is possible to set predefined curves for Open Lead Acid, Sealed Lead Acid, Gel, Ni-Cd, Li-Ion. They guarantee battery reliability over time by continuously testing the internal impedance status, avoiding any possible risk of damage and granting a permanent, reliable and safe connection of the battery to the power supply. The system includes a battery stimulation circuit and sophisticated algorithms to recognize sulphated batteries or batteries with a short-circuited element. Battery Test: Automatic. Battery

connection check: every 60 seconds. Battery efficiency test: every 220 minutes in float charge. Battery Faults can be monitored by relay and led blinking.

6.1 Battery Charge in Temperature compensated environment

No. 11 Auxiliary Output "AUX 1"

It is possible to connect the Temperature sensor probe and apply it on the battery. The function of the probe is for temperature battery compensation. With this it is possible to meet the requirements of the EN54- fire certification.



6.2 Battery Temperature Compensation Charge

Connecting the cable RJTEMP (supplied separately) to Auxiliary Output AUX1, the CBI will adjust the battery charging voltage in relation to the Battery temperature:

Fast Charge: Open Lead, AGM, Gel	Float charge: Open Lead, AGM, Gel
+/- 5mV/°C x n. of Cells from -8°C to +60°C +140 ± -200 mV/Cell compared to the value at 20°C	+/- 3mV/°C x n. of Cells from -20°C to +60°C +120 ± -120 mV/Cell compared to the value at 20°C
Fast Charge: Ni-Cd	Float charge: Ni-Cd
+/- 2.5 mV/°C x n. of Cells from -20°C to +60°C +100 ± -100 mV/Cell compared to the value at 20°C	+/- 2.5 mV/°C x n. of Cells from -20°C to +60°C +100 ± -100 mV/Cell compared to the value at 20°C

The device stops charging the battery if the temperature is below -20°C or above +60°C. The sensor placed on cable RJTEMP must be applied on the battery.

6.3 BatterySense connection

To determine the battery state of health "SoH", two additional wires must be connected close to the battery poles as shown in fig.4. The device must also be configured with battery data via the web server or Modbus/SNMP (see section "Ethernet configuration"). Please refer to the additional document "How to set SoCSoh" on battery data setting.

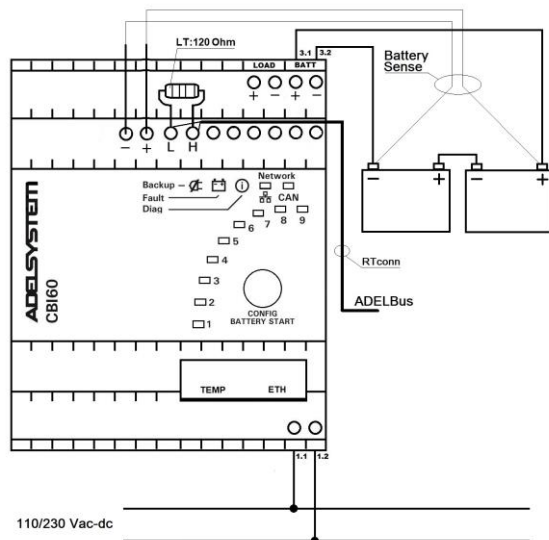

Fig. 4 – Battery Sense connection diagram

7 Device Configurations

Completely automatic, all devices are suitable to charge most batteries types thank to User Selectable charging curves. They can charge open lead acid, sealed lead acid, Gel, Ni-Cd and Li-Ion. It is possible to change or add other charging curves connecting the web server device to a PC.

7.1 Configurations

Note: it is also possible to configure the device via Web server
 In normal operation the LED bargraph (No.19 in sect.4.3) gives an indication of the current (0 to 100% of In) as follows:

- In charge mode with mains: battery charge current with **solid** light
- In backup mode without mains: battery discharge current with **blinking** light
- In boost mode with mains: battery discharge current with **flickering** light

To display the current device configuration on the LED bargraph press the Config/Start button (No.9 in sect.4.3) briefly (< 1 sec). The display returns to normal operation after 10 seconds. Please refer to the pictures at the end of this section.

To change the device configuration, complete the procedure below (note: if the procedure is not completed no settings are saved; the procedure is aborted if no command is given for 60s).

With battery disconnected:

- press the Config/Start button (No.9 in sect.4.3) for more than 2 seconds, until the first led starts blinking
- press briefly the button to cycle through the battery types as shown by LEDs 1,2,3 (please refer to the pictures at the end of this section) then confirm with a long press until the 4th LED starts blinking
- LED 4: Config Mode: ON/OFF
- Long press to enable a complete configuration via Web Server, Modbus/SNMP and DPY351 / ADELViewsystem (Led ON).
- Short press to configure basic parameters from the device front panel or from the web server System page (Led OFF)
- If Config Mode was selected, the procedure terminates here
- LED 5: Option: not used: continue with a short-press
- LED 6: Life Test; long press to enable the function (Led ON), short press to disable
- LED 7: Fast Charge; long press to enable the function (Led ON), short press to disable
- LED 8: UPS Disable; long press to disable the UPS function (Led ON), short press to keep it enabled
- LED 9: Buffering time: press briefly the button to select the max backup duration, then confirm with a long press. The current selection is shown with other LEDs blinking together with LED 9 as follows:
 - Led 1: 30 sec; Led 2: 120 sec; Led 3: 300 sec; Led 4: 10 min; Led 5: 15 min; Led 6: 20 min; Led 7: 30 min; Led 8: 45 min; All leds: Infinite time
- Note: the last selection (infinite time) is confirmed automatically also with a short press
- More values can be selected by Web Server, Modbus, SNMP and with DPY351 or ADELViewsystem
- End Programming: the device shows the selected configuration for 10 seconds then resumes normal operation,

With battery connected:

- press the Config/Start button (No.9 in sect.4.3) for more than 2 seconds, until the 5th led starts blinking
- follow the procedure above from step "LED 5: Option" (Battery Type and Config Mode can be changed only when the battery is not connected).

Battery Type chemistry Selection			
	LED Config	Float charge (Volt/Cell)	Fast charge (Volt/Cell)
Open Lead		2.23	2.40
(AGM) Low		2.25	2.40
Gel Battery		2.30	2.40
Ni-Cd		1.4V/cell (12V:10 cells) (24V:20 cells) (48V:40 cells)	1.45V/cell (12V:10 cells) (24V:20 cells) (48V:40 cells)
Li-Ion (4) LiFePo4		3.45V/cell 12Vfield: 13.8V 24Vfield: 27.6V 48Vfield: 55.2V	3.65V/cell 12Vfield: 14.6V 24Vfield: 29.2V 48Vfield: 58.4V
Config Mode (5)		Configure with ADELViewsystem or Web Server for CBI60	

Functional Setting		
Battery Life test ON		Life test enabled
Fast Charge Enable (3)		Fast Charge enabled.
UPS Disabling		UPS function disabling. Use terminal 12 for connection to external Contact.
Time Buffering		1 blink => 0.5, 2 blink => 1, 3 blink => 5, 4 blink => 10, 5 blink => 15, 6 blink => 20, 7 blink => 30, 8 blink => 45 min 9 Solid => ∞ infinite” (Time = minute)

8 Data and Communication

8.1 ADELBus connection

Remote device connection by terminals 22 section 4.3. This device features the ADELBus communication protocol for the connection of other devices on CAN bus, for monitoring, configuring, driving and updating them(fig.3).

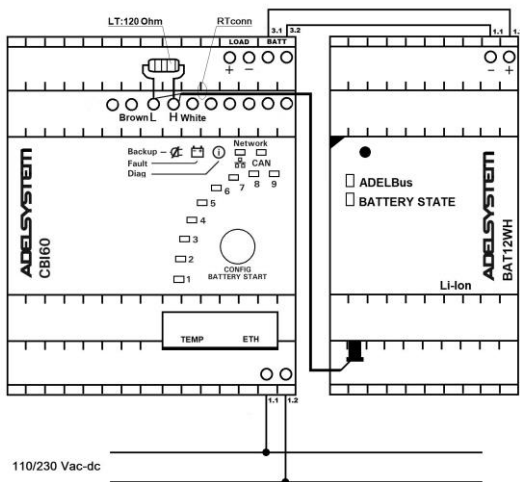

Fig. 3 – Connection to DC Ups

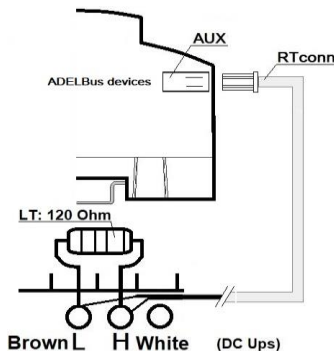

Fig. 4 –Connection RTConn cable

For the ADELBus connection, please connect the cable RTConn to AUX1 on the device as shown in Fig.4 and connect the other side of the cable to the CAN terminals L (Brown) and H (White) of the CBI60, with a line termination (LT) resistor 120 Ohm, present inside the Cable Kit: KITCANCONNECTION.

9 Ethernet Configuration

Configuration of the Ethernet interface by HTTP server via the Web browser:

9.1 Connect HTTP server for the first time

Connect the device to the network with a standard CAT5e or better LAN cable plugged into the Aux4 connector (RJ45) on the bottom of the unit, as shown in section 4.3. The CBI60 is factory-configured to operate with a fixed IP address (192.168.1.100) on the standard HTTP port (number 80).

A different static IP address can be assigned to the CBI60 or a dynamic IP address can be assigned using the DHCP protocol. The network configuration can be carried out using the internal webserver. Type the IP address of the CBI60 into any browser's address bar (as an example "192.168.1.100") then the login page appears requesting the username and the password.

To access the internal webserver, at the login page, the following credentials must be used:

Username: admin

Password: password

Note: after 20 minutes of inactivity the login credentials must be entered again.

9.1.1 Customizing the ethernet interface and services

Select "Configuration" and then "Network" to display the following groups of parameters and other informations:

- Account
- Generic configuration
- TCP/IP Configuration
- HTTP(s) Configuration
- SNMP

9.1.2 Account:

The Account group (Fig. 6) allows the customization of the data for the HTTP server login page. Any changes must be confirmed with the confirm button at the bottom of the page.

Fig. 6 – Account settings

9.1.3 Generic and TCP/IP Configuration

Fig. 7 shows the TCP/IP Configuration group with parameter default values. They allow unique identification of the unit in the network.

Fig. 7 – IP settings

If "Dynamic (DHCP)" is selected, the IP address is automatically assigned by a DHCP server, that must be active on the network; in this case the System IP, Subnet Mask and Gateway textboxes show the assigned values and are not editable.

The CBI60 supports access using the Virtual LAN protocol. In the case "VLAN ID" checkbox is not selected the CBI60 will not operate in the VLAN. If "VLAN ID" checkbox is selected then a "VLAN ID" textbox will appear and should be populated with an ID in the range 1 to 4094, matching the one of the VLAN the unit is operating in.

Any changes must be confirmed with the confirm button at the bottom of the page.

9.1.4 HTTP(s)

The CBI60 supports HTTP and HTTPs protocols. If the client system supports multicast DNS (mDNS) the device can be accessed by its name (as set under Generic Configuration) followed by ".local".

HTTP Port allows redirecting the HTTP traffic to a port different than the standard HTTP port 80. In that case, access to the HTTP server from a browser must be made using the syntax <http://ipaddress:portnumber>.

As an example, if the IP address is 192.168.1.100 and the selected HTTP port is 5678 then the following IP string should be entered in the browser <http://192.168.1.100:5678>.

Secure HTTP (HTTPS) can also be selected, using an internal certificate or a certificate provided by the customer.

Fig. 8 – HTTP(s) configuration

9.1.5 SNMP

The CBI60 can act as SNMP server. An ADELSYSTEM MIB table file is provided which consists of a list of parameters that can be remotely read, or read-written through the SNMP protocol. Each parameter (OID) is mapped one-to-one to a Modbus RTU holding register. Refer to the document “Adelsystem parameter table” for the description of each parameter.

Fig. 9 – SNMP settings

All the fields in the SNMP group of settings allow a maximum of 31 characters, except “System Description” and “System Location”, which allow 255 characters maximum. The actual content of the page depends on the SNMP version selected (v1, v2c or v3).

Any changes must be confirmed with the confirm button at the bottom of the page.

9.1.6 Device status

The Dashboard page shows the main operating parameters of the device.

Fig. 10 – Device status

9.1.7 System settings

The System page under Configuration shows detailed information on the device and installed software, to be communicated to the service technician if requested. Fig. 11 shows example information: the actual values will be different.

The “device identification” button allows to locate the CBI60 by emitting a beep and turning on all leds in sequence.

The “System reset” button allows to reboot the device remotely, only if no battery connected. Current settings will be maintained. Any changes not saved with the confirm button will be lost.

“System configuration” and “Manual settings” replicate the settings also accessible on the CBI60 front panel by pressing the CONFIG button (refer to the relevant section of this manual). Any changes must be confirmed with the confirm button at the bottom of the page.

“Battery type” selects the battery chemistry from a drop-down list.

If “Configuration mode” is selected Led 4 ON, the following parameters (Lifetest, Fast charge, UPS enable and time Buffering time) cannot be changed as they are controlled remotely via Modbus or SNMP.

If “Configuration mode” is not selected Led 4 OFF, the following settings are available: “Lifetest”, “Fast charge”, “UPS disable” and “Time buffering”.

The “Charging current” sets the battery charge current limit.

Fig. 11 – Device settings

9.1.8 Saving the customized parameters

To save the changes into the CBI60 non volatile memory press the confirm button at the bottom of the page.



9.2 How to restore default values in the device (Customer service)

9.2.1 Resetting the customized parameters to their default values

In case the login user name or password was forgotten, or the TCP/IP configuration was set incorrectly and the device is no longer reachable, please follow this procedure to restore the default settings:

- Turn OFF the device
- Press the CONFIG button on the front panel and keep it pressed
- Turn ON the device and continue to keep the button pressed (all the 9 configuration LEDs will stay ON during this time)
- After 5 seconds the 4 top configuration LEDs (n. 6 to 9) will blink alternatively in pairs and the LED 1 will blink slowly showing “Option 1”
- Release the button
- Now click briefly on the button to select one of 4 options, as shown by the config LEDs 1 to 4. The options are:
 - 1: forces Dynamic (DHCP) IP Addressing Mode (DHCP) until reboot; the TCP/IP configuration must be changed on the HTTP server in order to make this setting permanent.
 - 2: system recovery application, only to be used if instructed by customer service
 - 3: restore login credentials, TCP/IP and SNMP settings to factory default
 - 4: restore the complete device to factory settings – WARNING: all user’s settings and logs will be lost, including the battery type selection.
- Confirm the choice by keeping the CONFIG button pressed for 5 seconds until LEDs 6 to 9 stop blinking.

10 Disposal guideline

Recycling all package and packaging aids. The device must be recycled not in domestic recycling.

11 Technical Data

Please Refer to product Data Sheet